

Submersible Centrifugal Pump

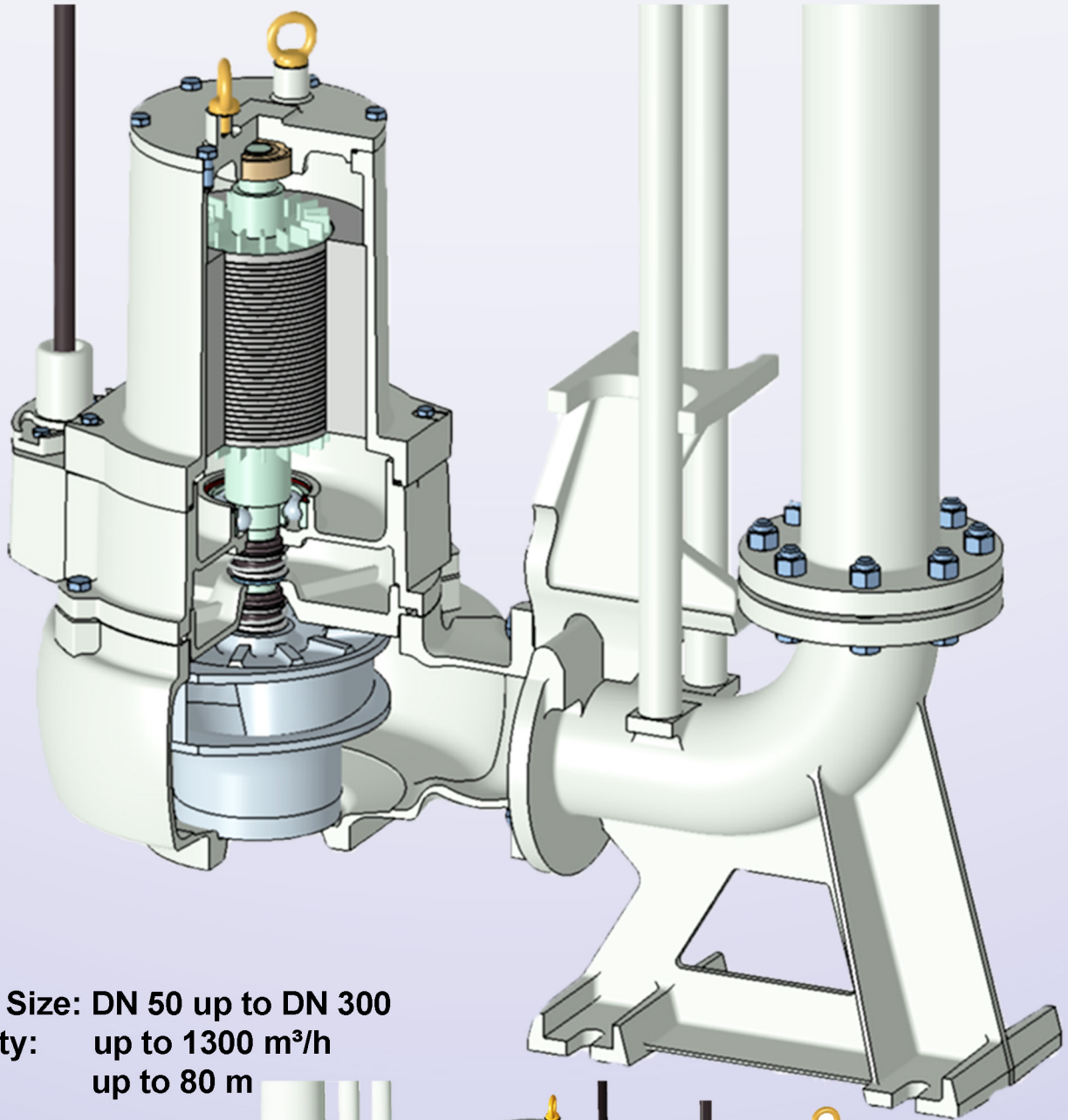

Flange Size: DN 50 up to DN 300
Capacity: up to 1300 m³/h
Head: up to 80 m

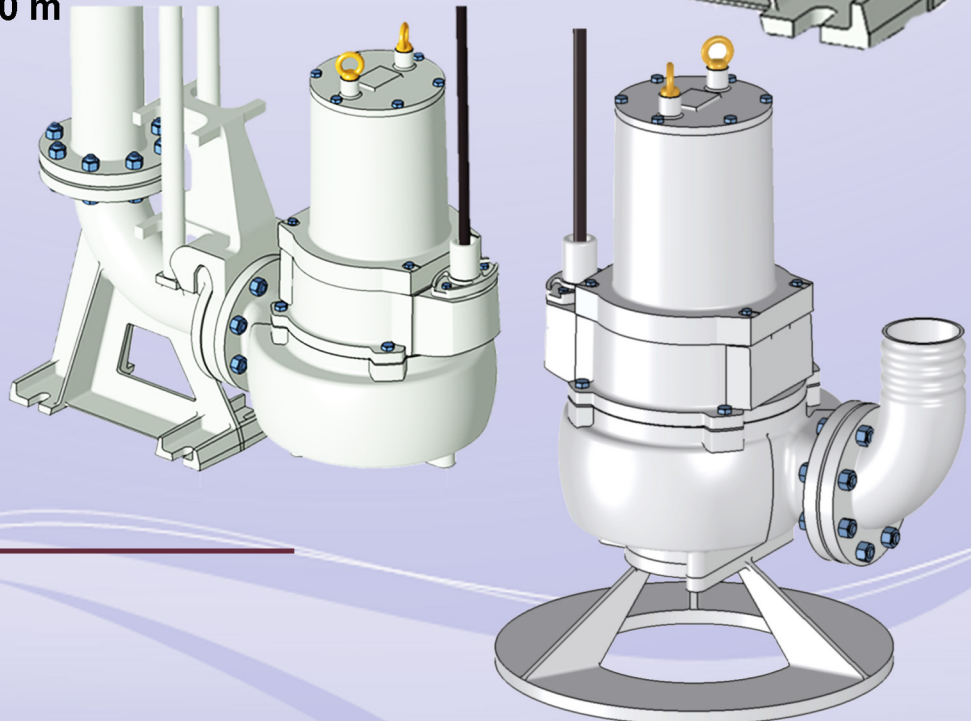

BERKEH
Pumps

Factory: +9821 56546894-7
Office: +9821 22346378-9
www.berkeh.com
sales@berkeh.com
berkehpumps@yahoo.com

Submersible Sewage Pump

TYPE: 40-125/A	IMPELLER TYPE: Free Flow
2850 rpm	

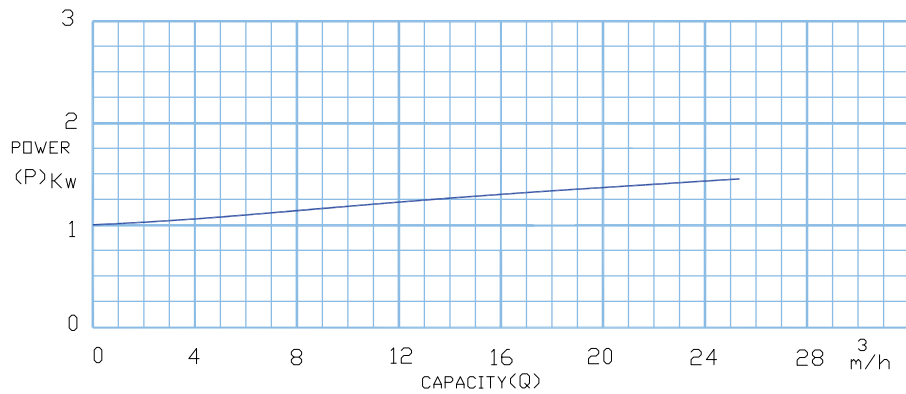
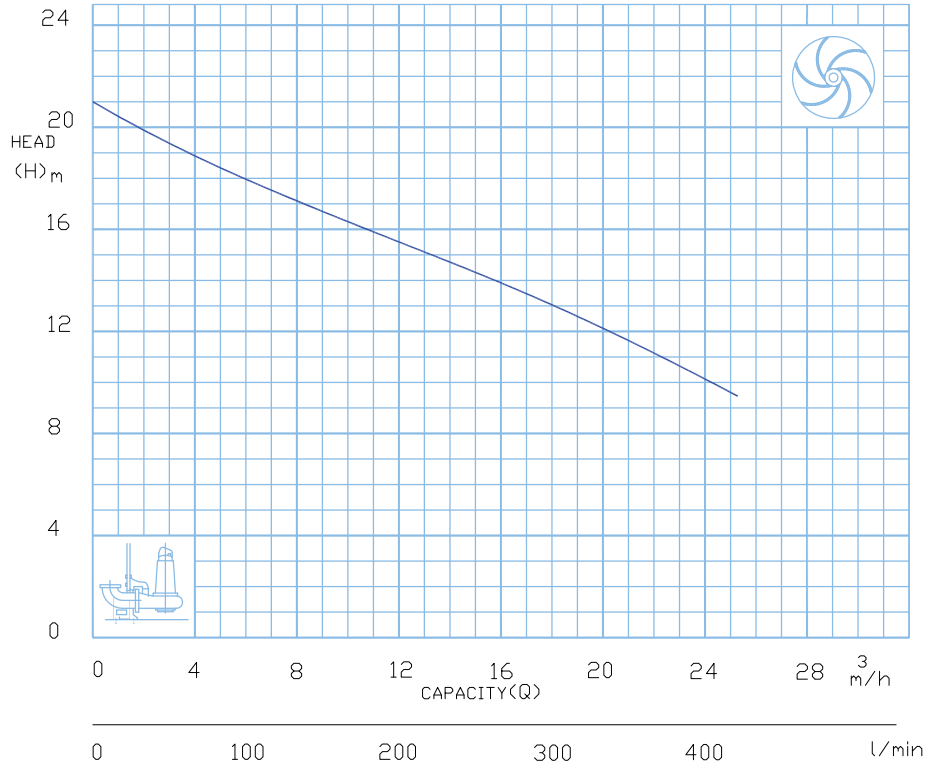

Submersible Sewage Pump

TYPE: 40-125/M	IMPELLER TYPE: Multi-Channel
2850 rpm	

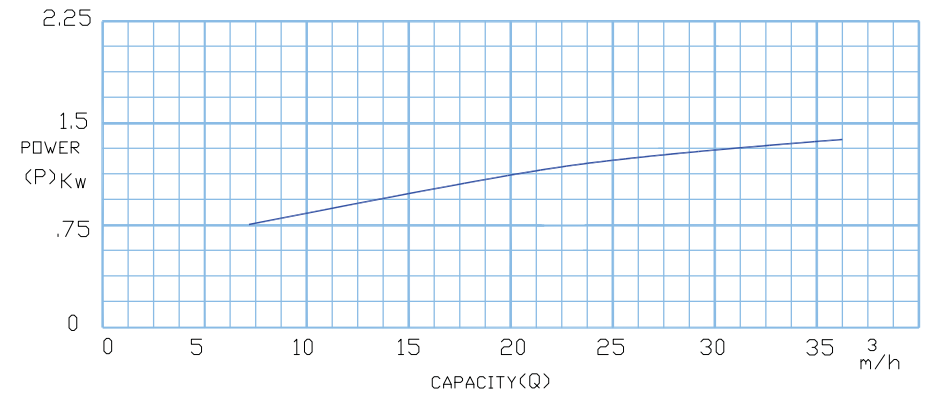
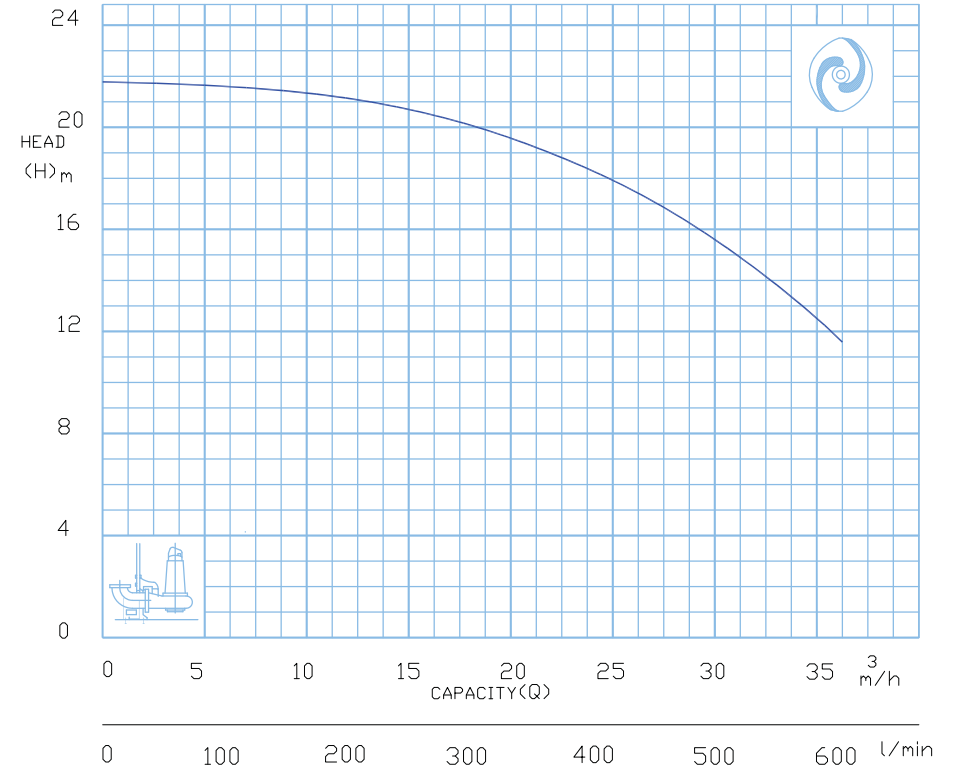

Submersible Sewage Pump

TYPE: 50-100/S	IMPELLER TYPE: Single-Channel
2850 rpm	

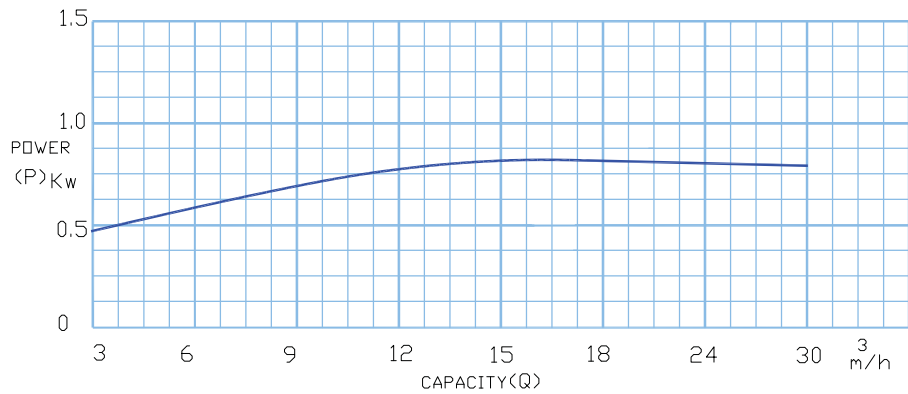
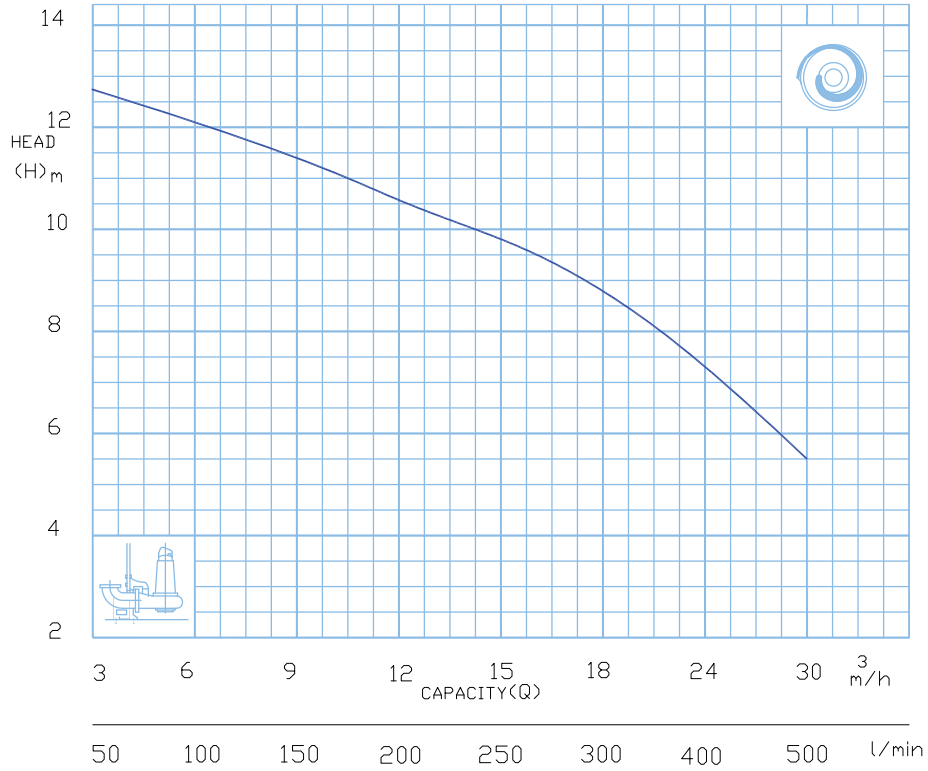

Submersible Sewage Pump

TYPE: 50-125/S	IMPELLER TYPE: Single-Channel
2850 rpm	

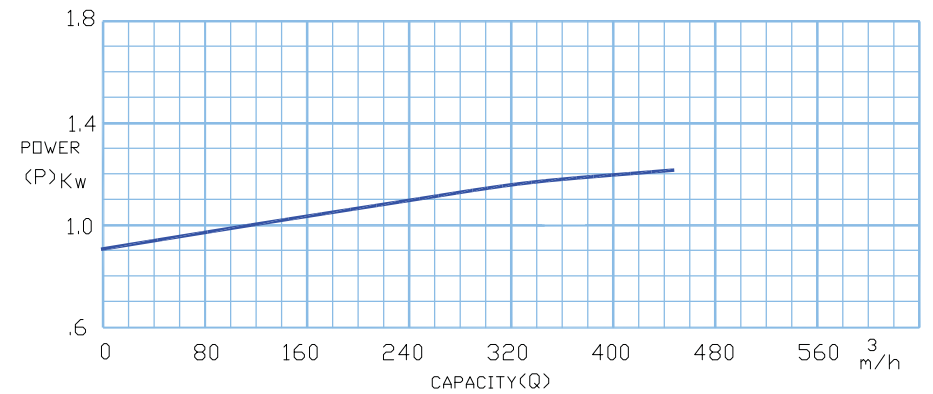
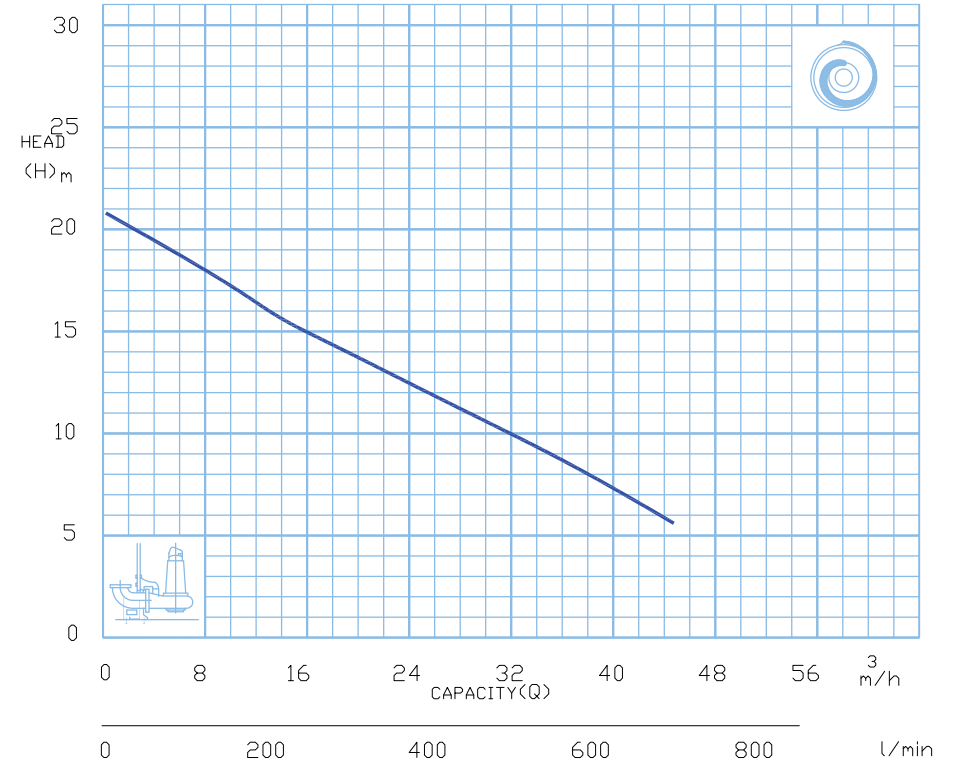

Submersible Sewage Pump

TYPE: 65-200/A	IMPELLER TYPE: Free Flow
1450 rpm	

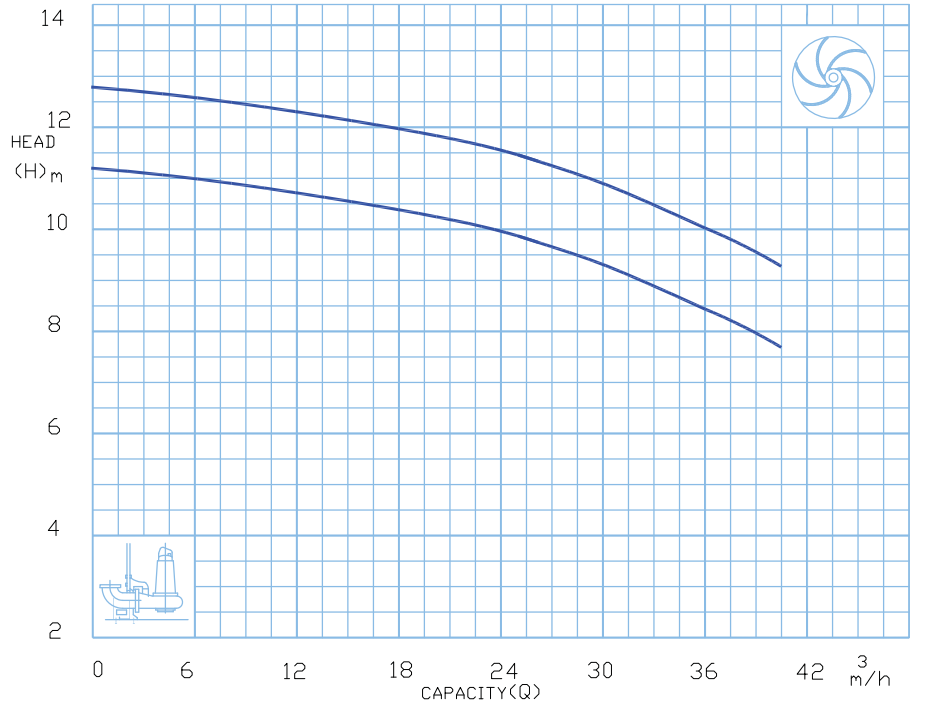

0 100 200 300 400 500 600 700 l/min

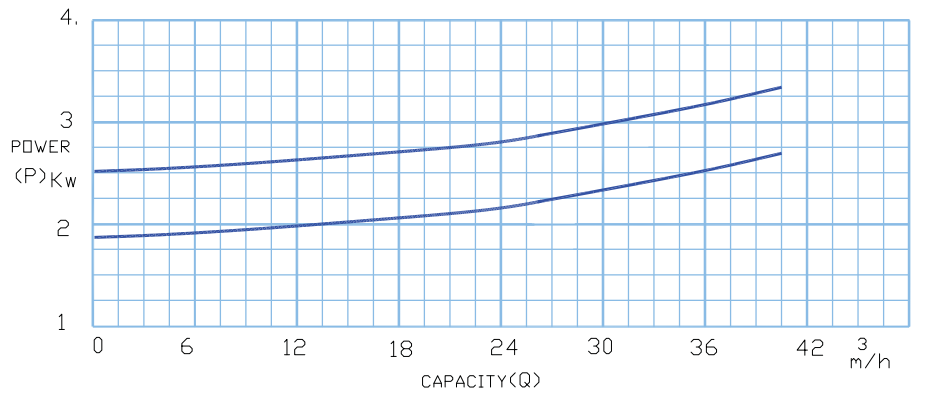

Submersible Sewage Pump

TYPE: 80-125/S2	IMPELLER TYPE: Single-Channel
2900 rpm	

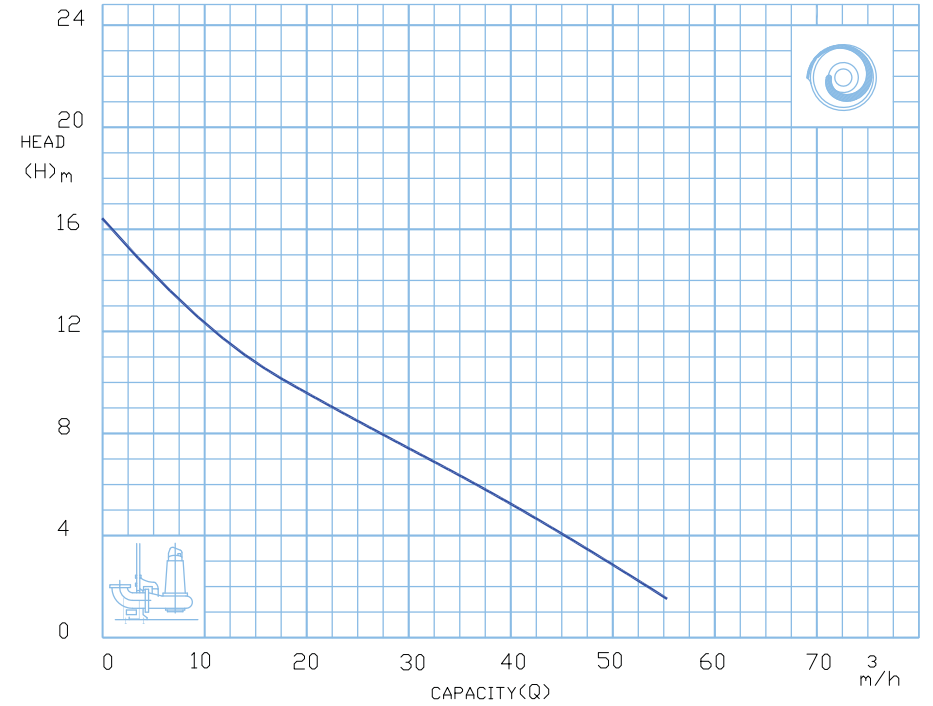

0 200 400 600 800 1000 1200 l/min

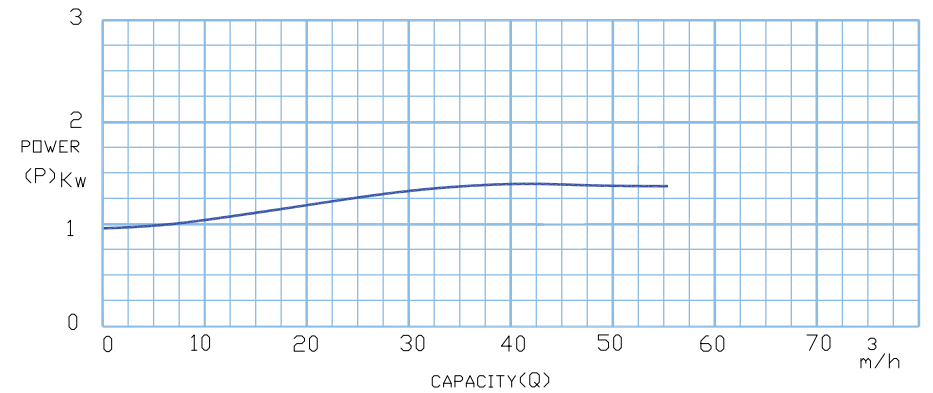

Submersible Sewage Pump

TYPE: 80-125/S3	IMPELLER TYPE: Single-Channel
2900 rpm	

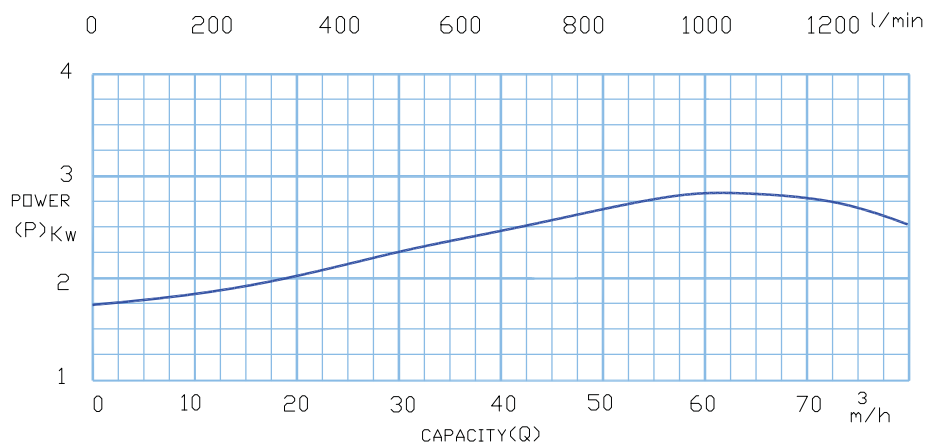
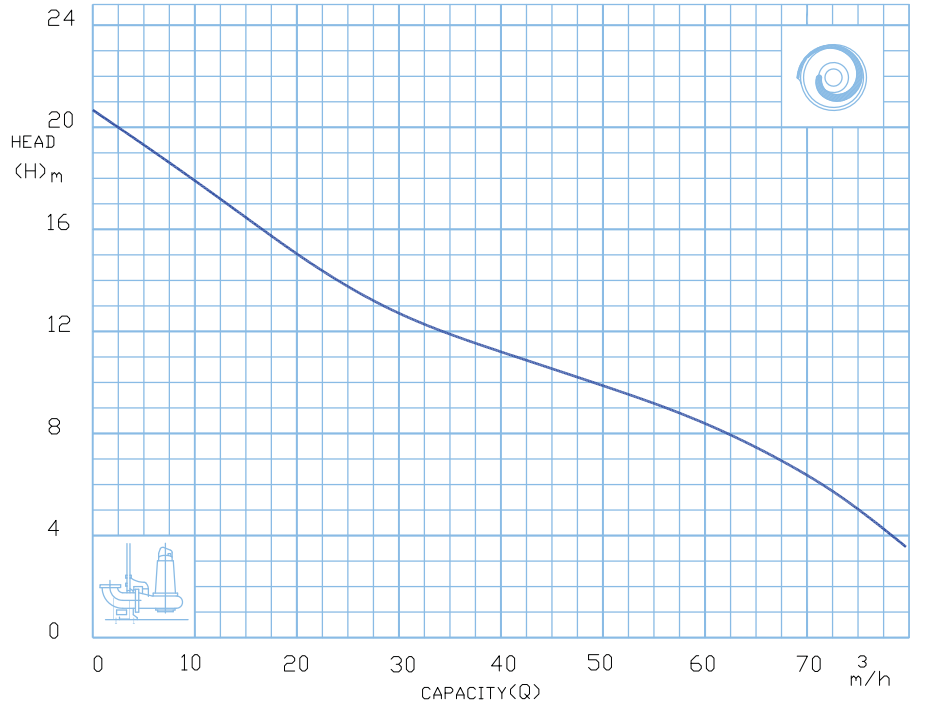

Submersible Sewage Pump

TYPE: 80-200/S	IMPELLER TYPE: Single-Channel
2850 rpm	

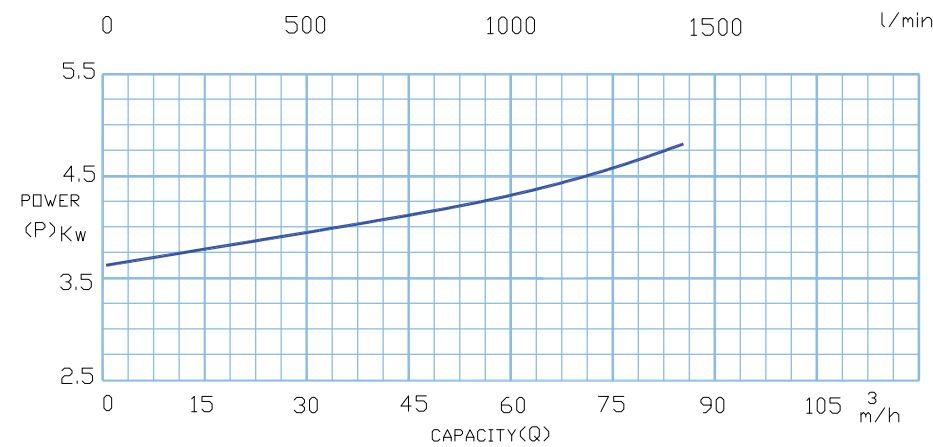
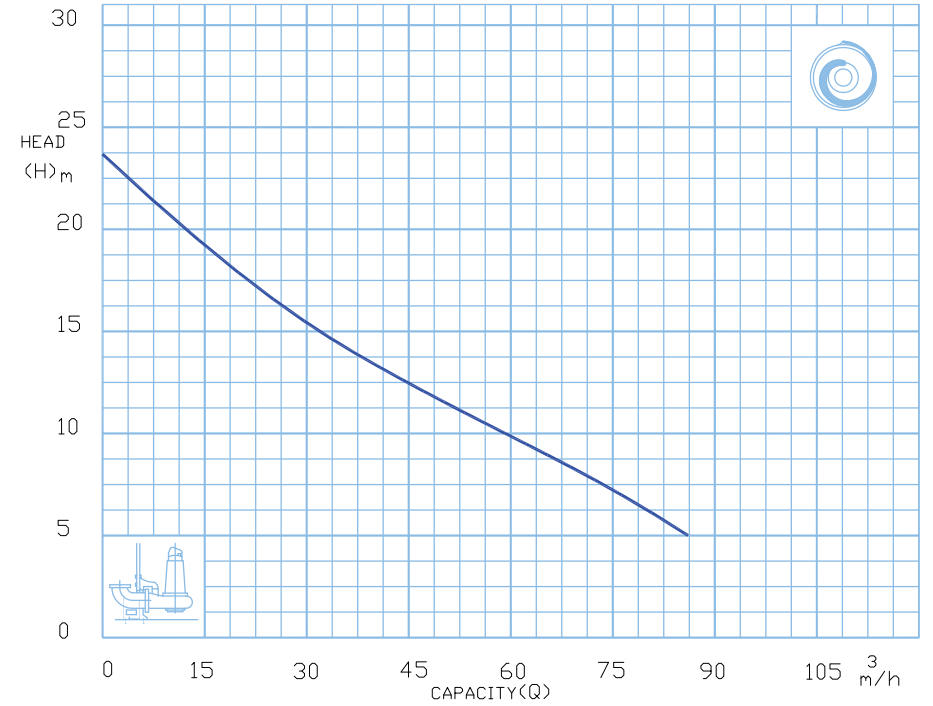

Submersible Sewage Pump

TYPE: 80-315/A	IMPELLER TYPE: Free Flow
1450 rpm	FREE PASSAGE: 70Ø

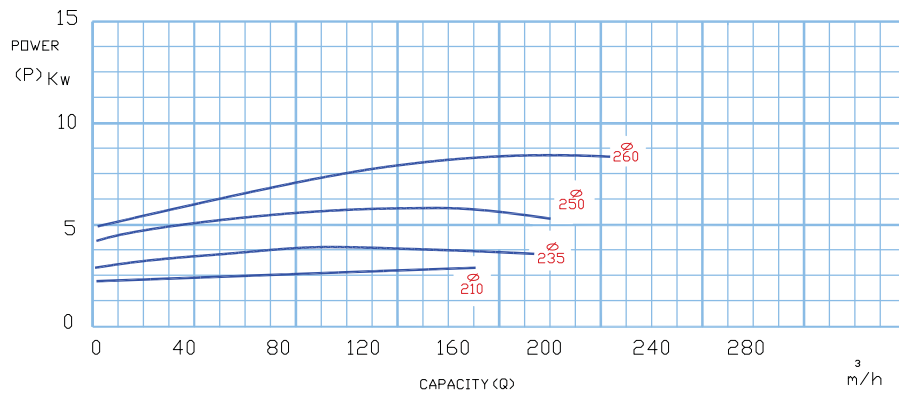
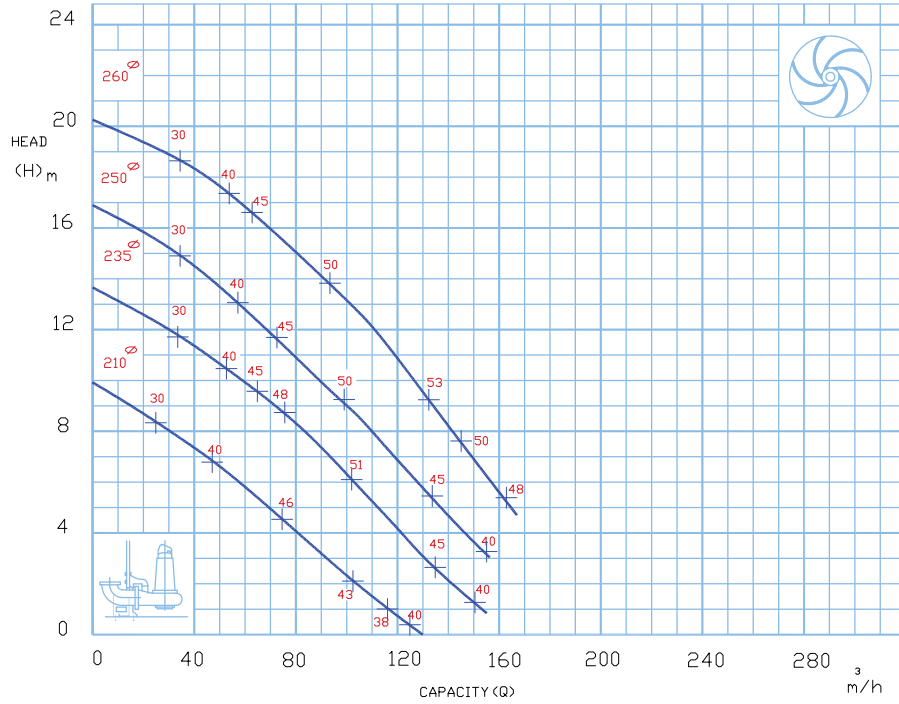

Submersible Sewage Pump

TYPE: 80-315/S	IMPELLER TYPE: Single channel
2900 rpm	FREE PASSAGE: 40Ø

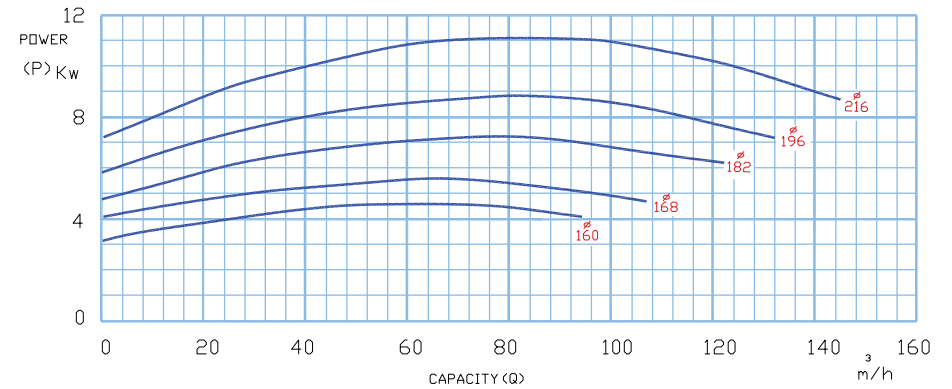
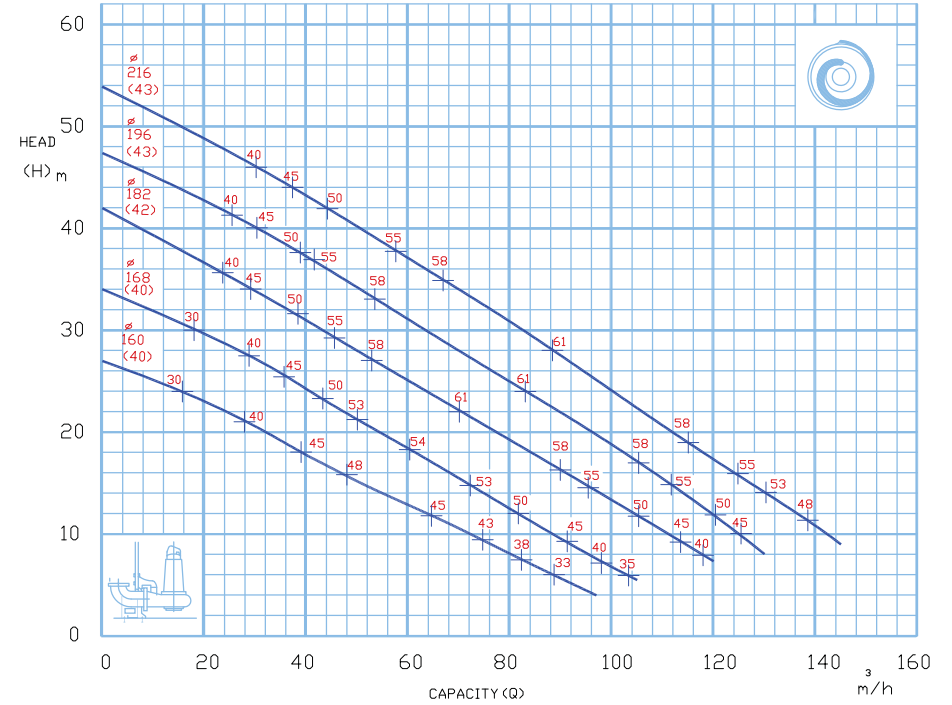

Submersible Sewage Pump

TYPE: 100-250/A	IMPELLER TYPE: Free Flow
1450 rpm	FREE PASSAGE: 100ø

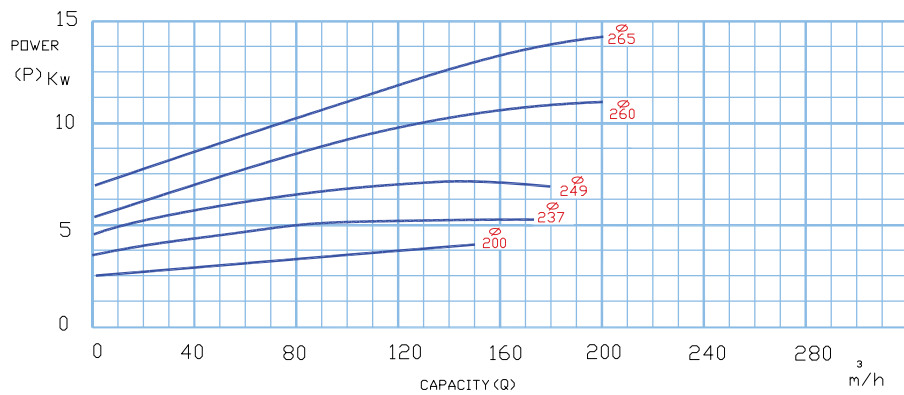
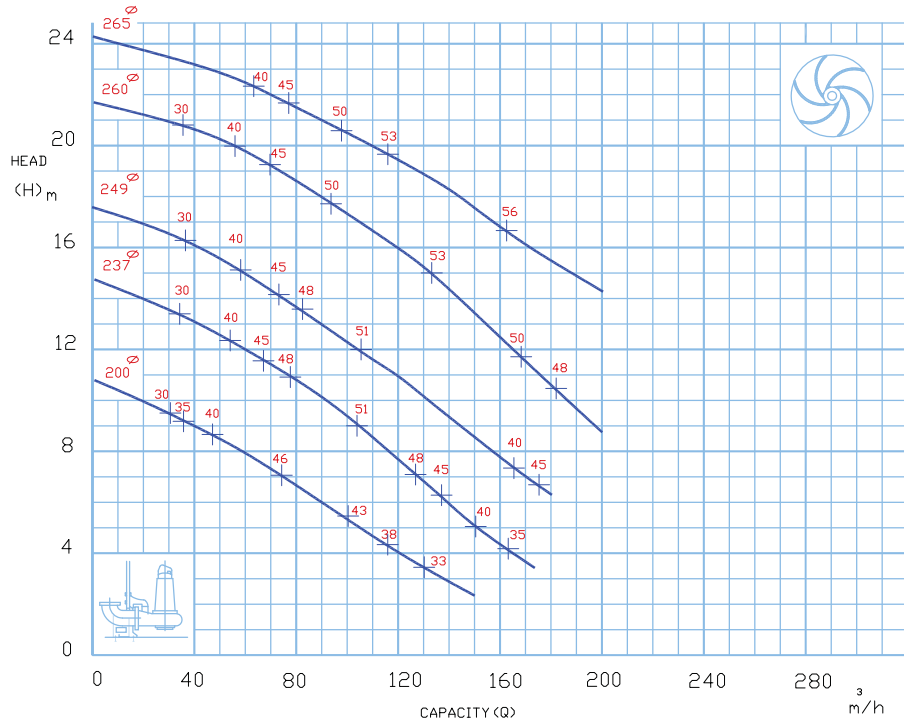

Submersible Sewage Pump

TYPE: 100-250/M	IMPELLER TYPE: Multi-channel
1450 rpm	FREE PASSAGE: 55X55

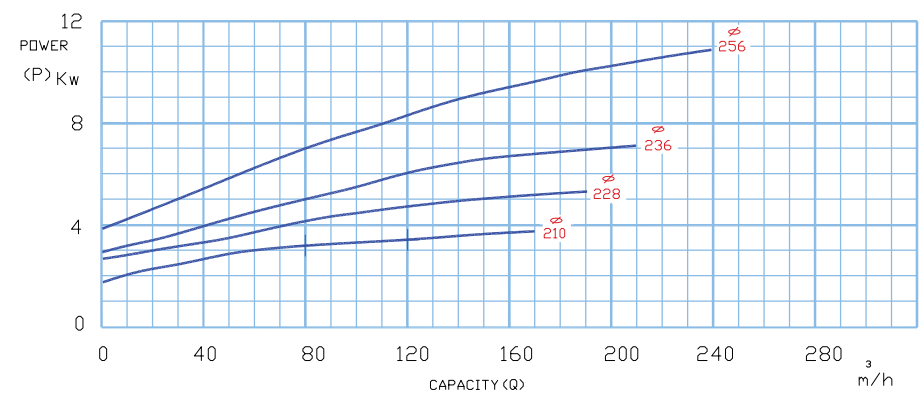
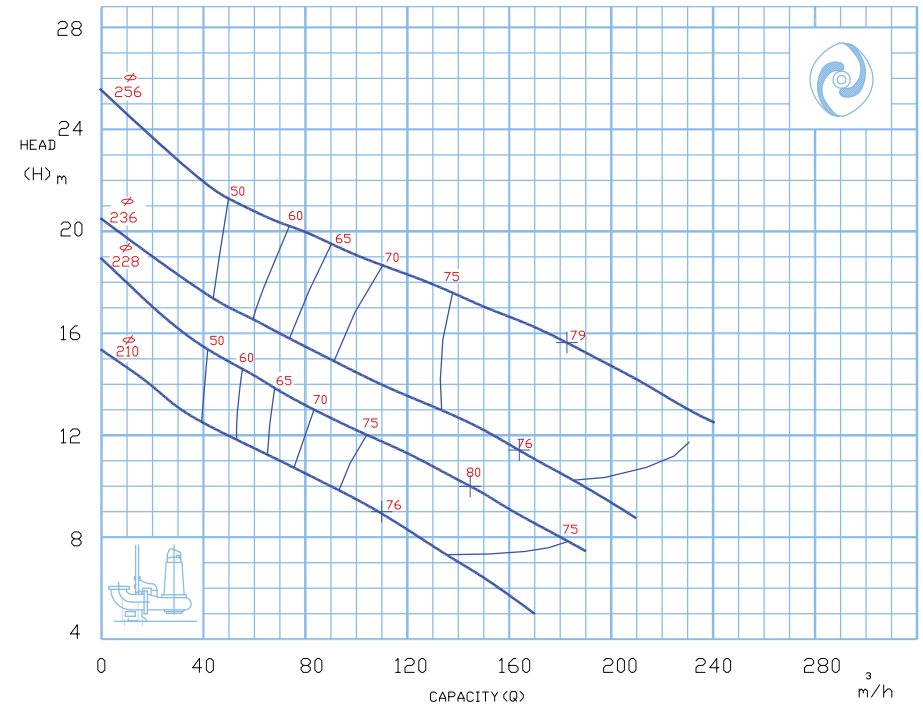

Submersible Sewage Pump

TYPE: 100-250/S	IMPELLER TYPE: Single channel
1450 rpm	FREE PASSAGE: 90°

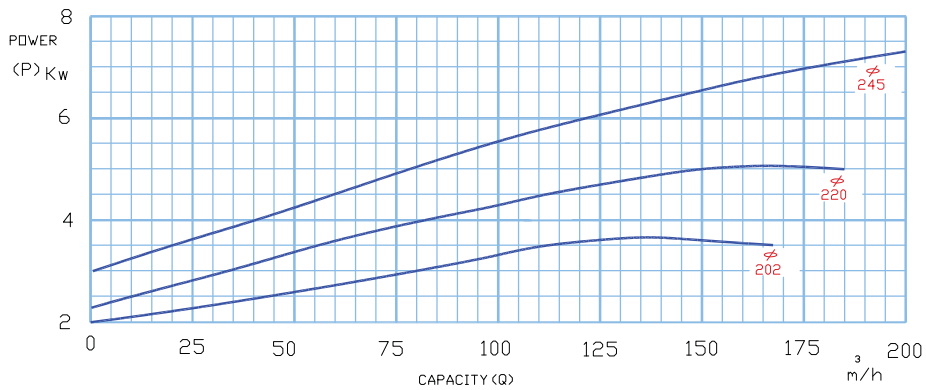
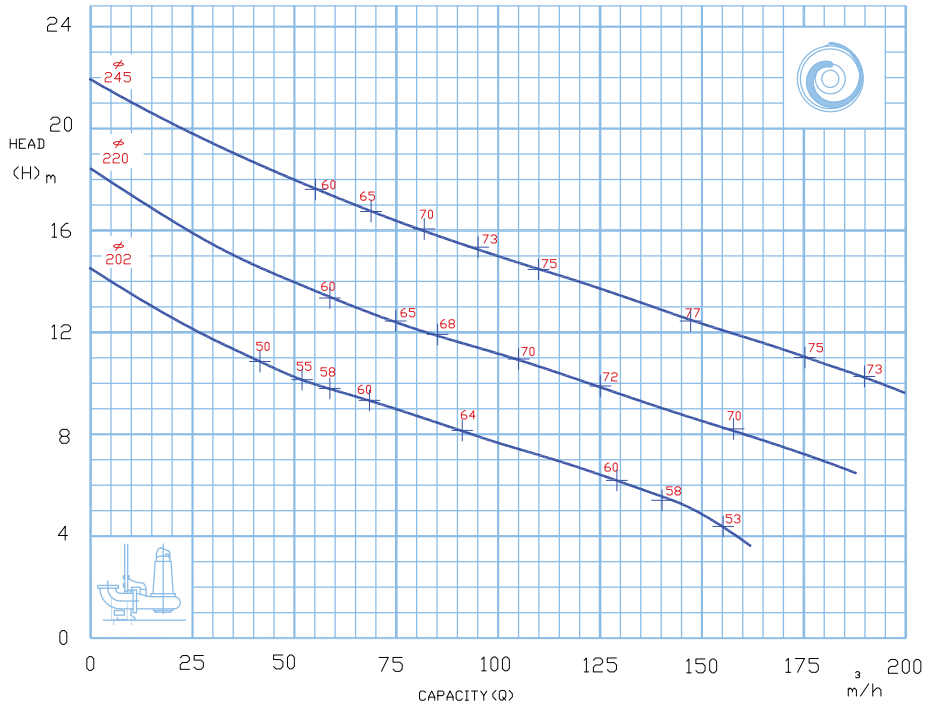

Submersible Sewage Pump

TYPE: 100-315/M	IMPELLER TYPE: Multi-channel
1450 rpm	FREE PASSAGE: 75X81

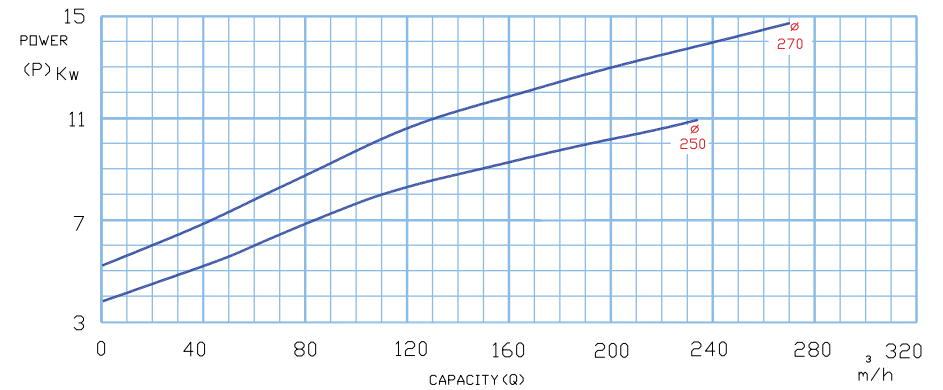
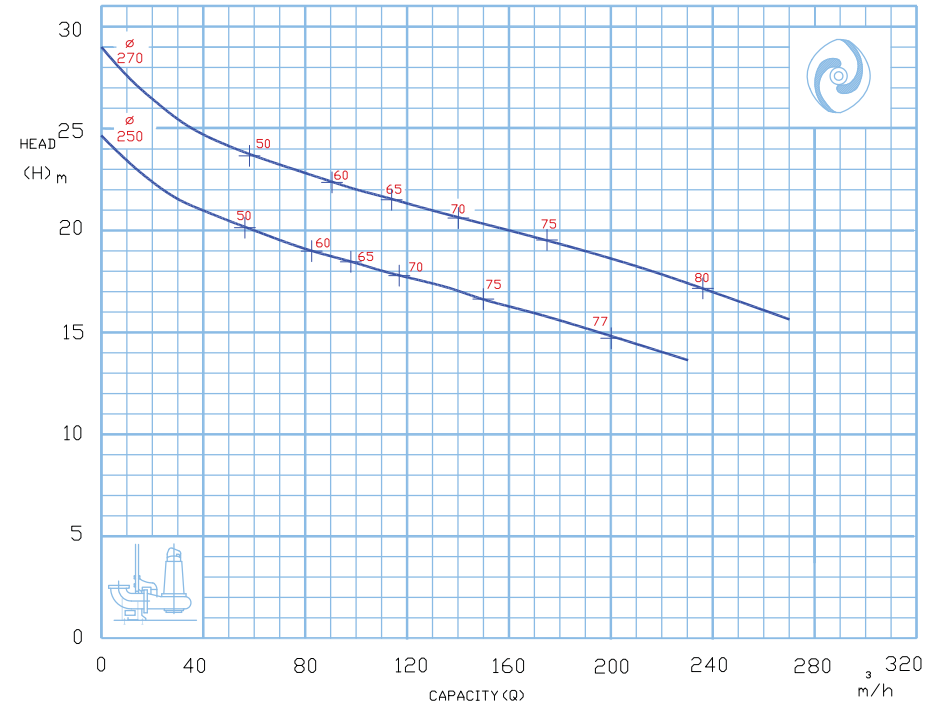

Submersible Sewage Pump

TYPE: 100-315/S	IMPELLER TYPE: Single channel
1450 rpm	FREE PASSAGE: 100Ø

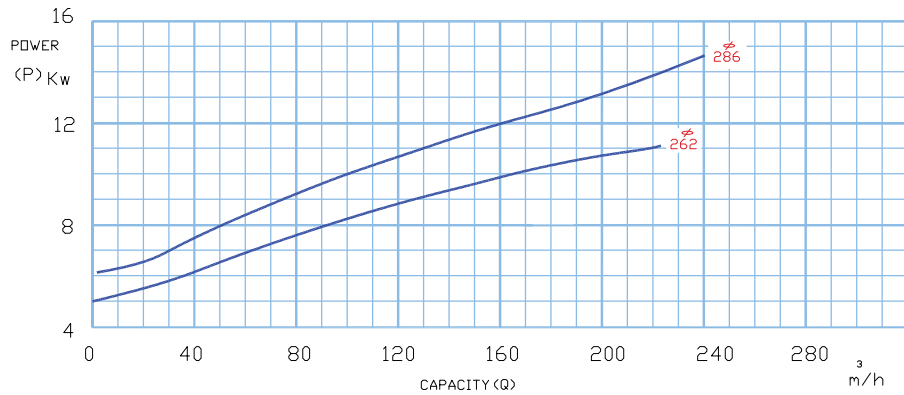
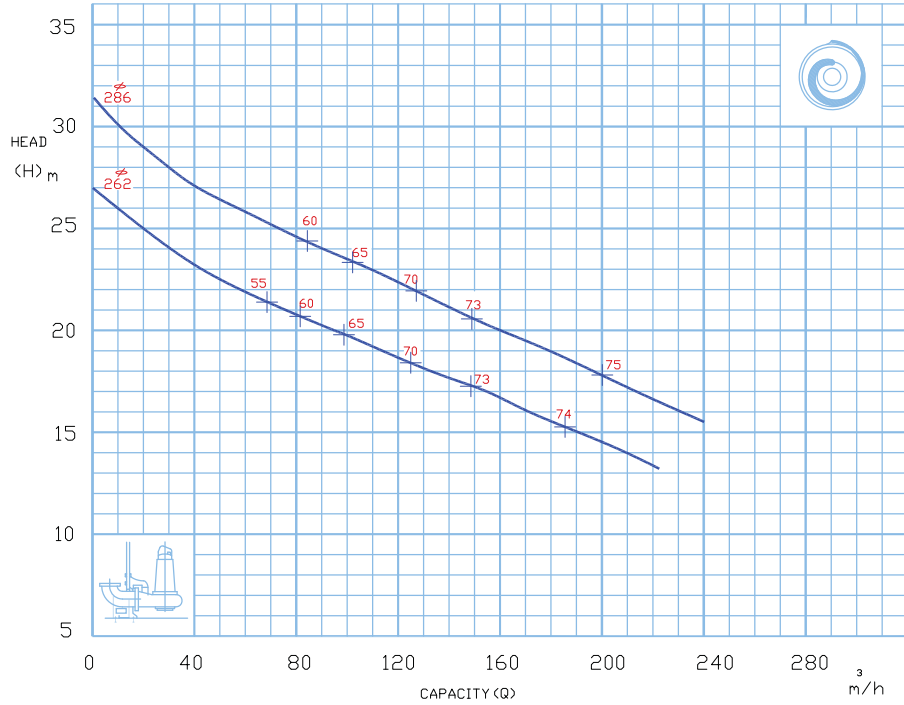

Submersible Sewage Pump

TYPE: 100-320/M	IMPELLER TYPE: Multi-channel
1450 rpm	FREE PASSAGE: 55X54

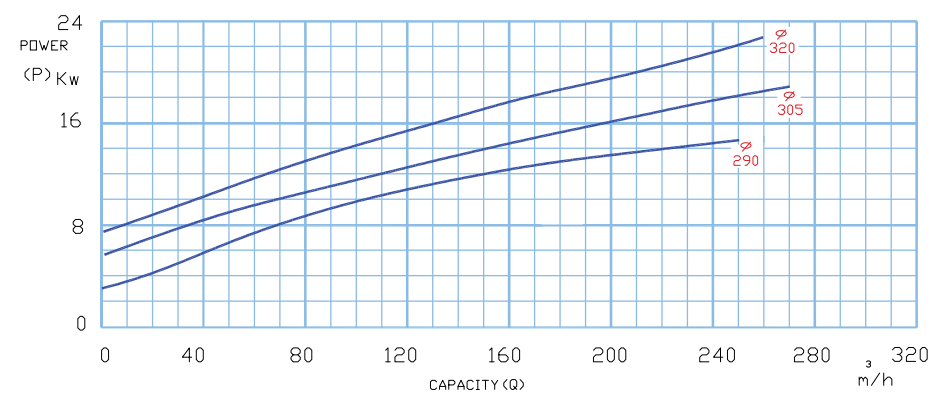
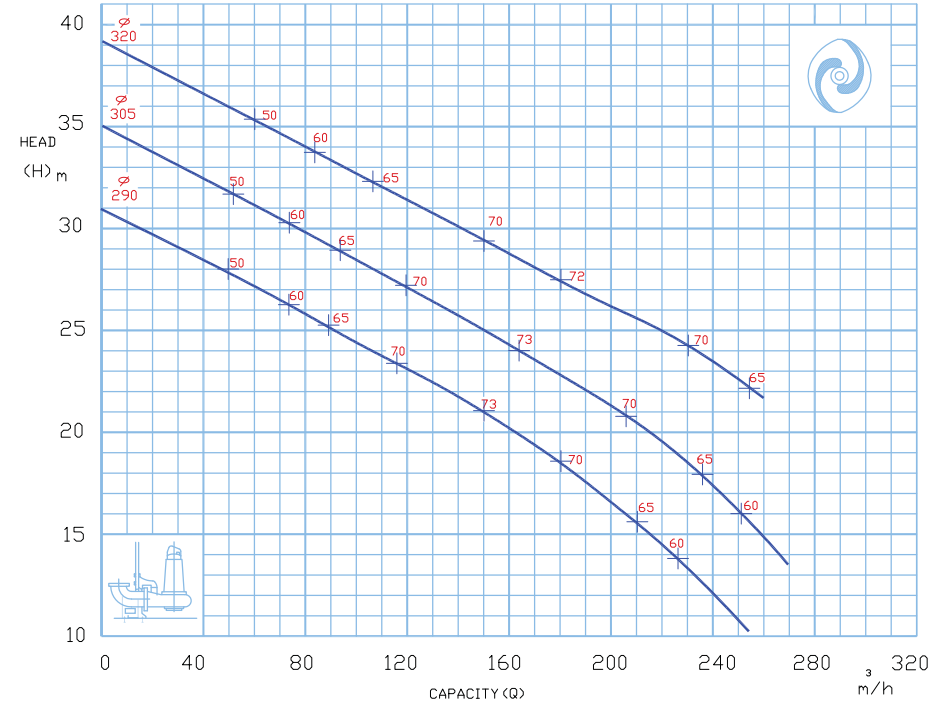

Submersible Sewage Pump

TYPE: 100-320/S	IMPELLER TYPE: Single channel
1450 rpm	FREE PASSAGE: 80ø

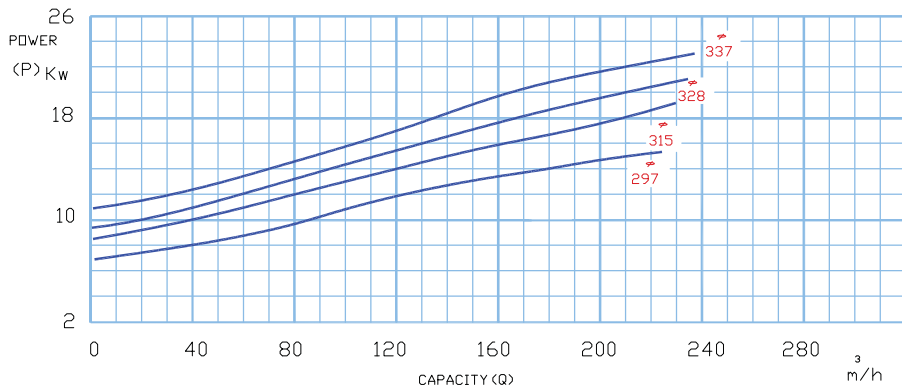
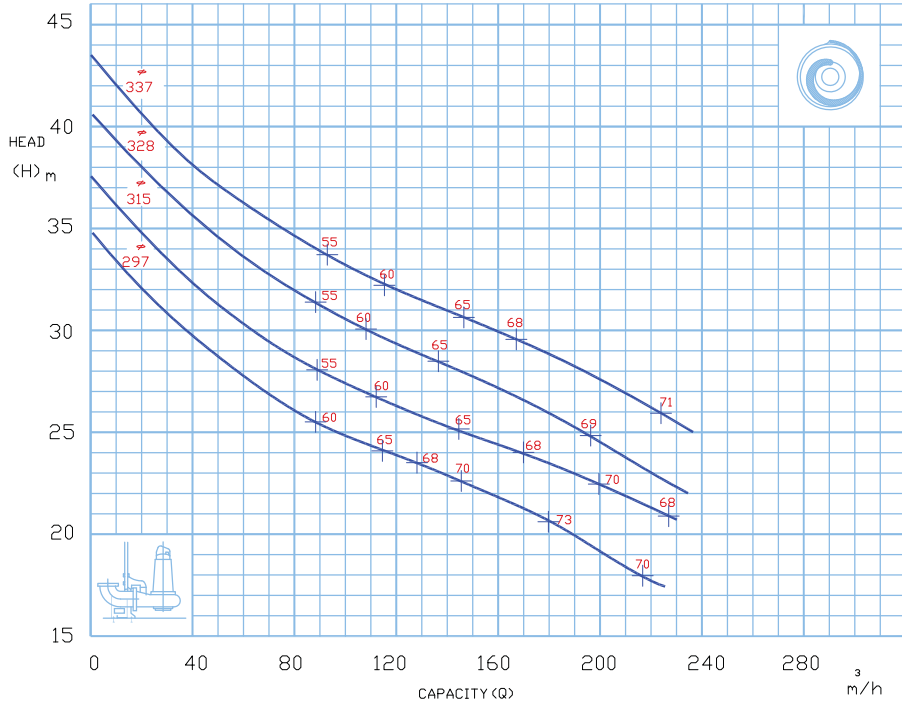

Submersible Sewage Pump

TYPE: 100-400/M	IMPELLER TYPE: Multi-channel
1450 rpm	FREE PASSAGE: 50X50

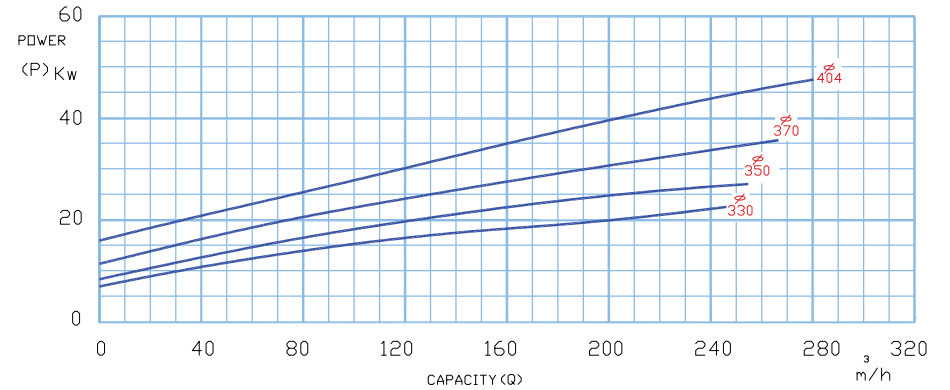
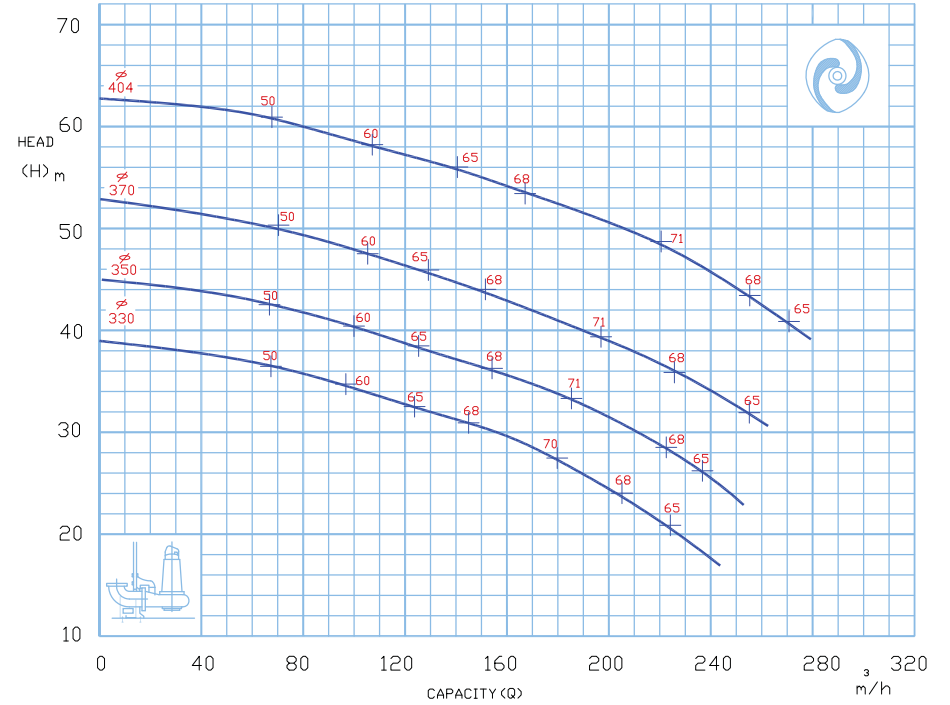

Submersible Sewage Pump

TYPE: 100-400/S	IMPELLER TYPE: Single channel
1450 rpm	FREE PASSAGE: 80X95

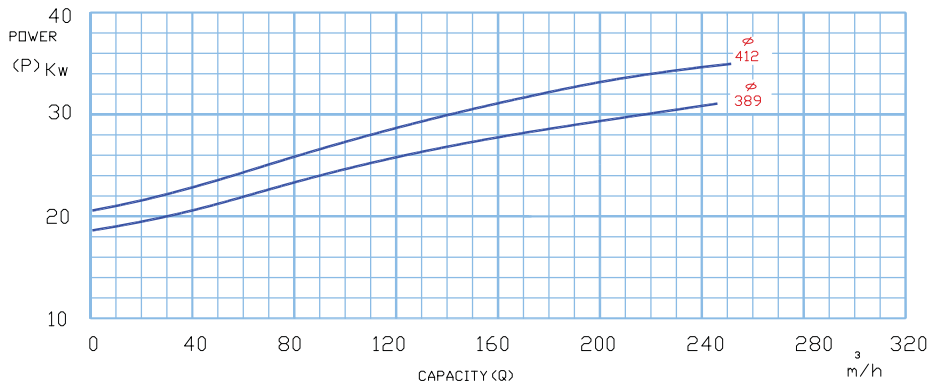
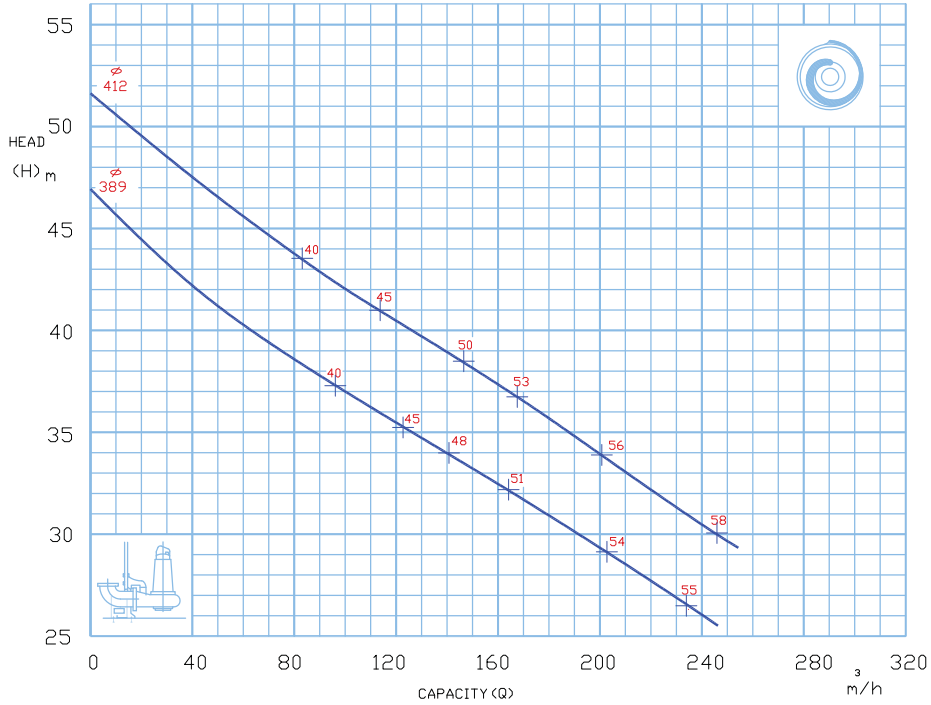

Submersible Sewage Pump

TYPE: 150-315/A	IMPELLER TYPE: Free Flow
960 rpm	FREE PASSAGE: 120Ø

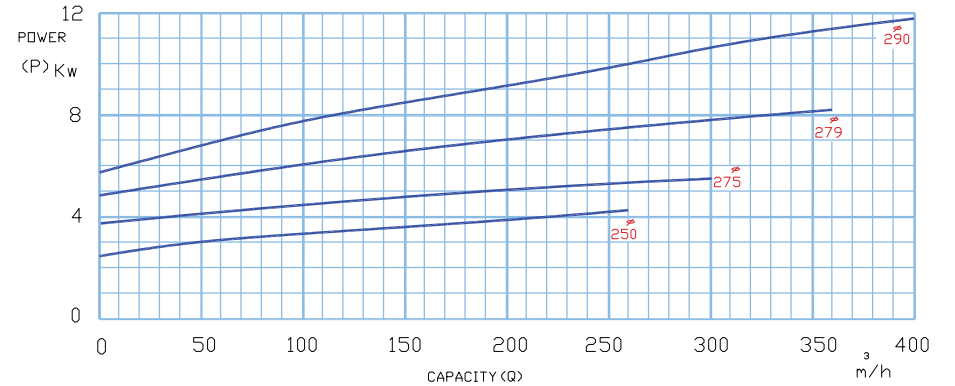
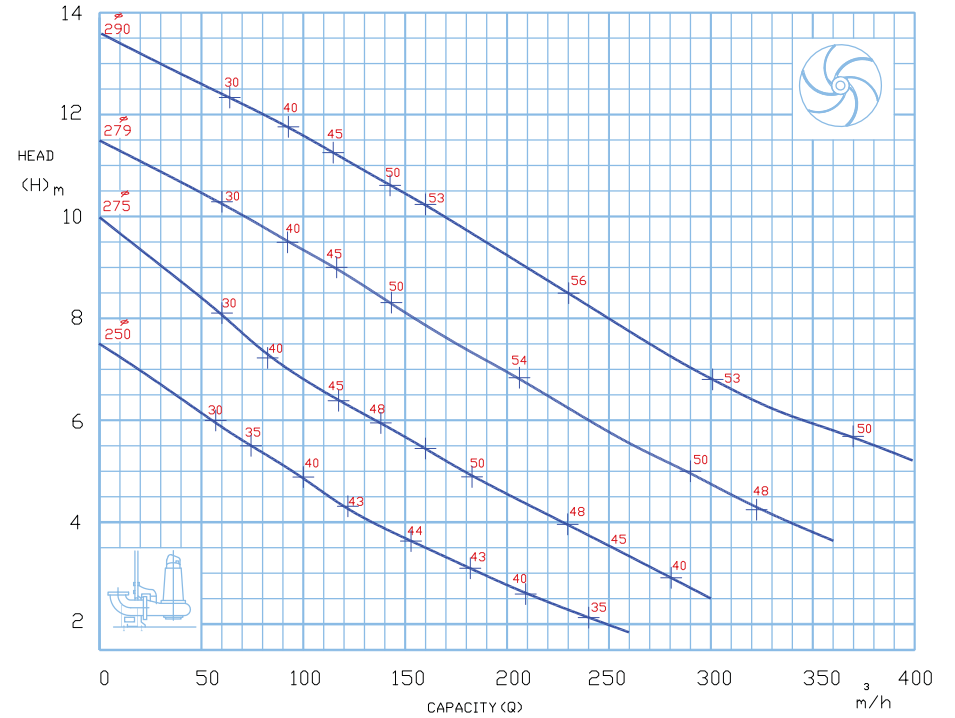

Submersible Sewage Pump

TYPE: 150-315/M	IMPELLER TYPE: Multi-channel
1450 rpm	FREE PASSAGE: 58X85

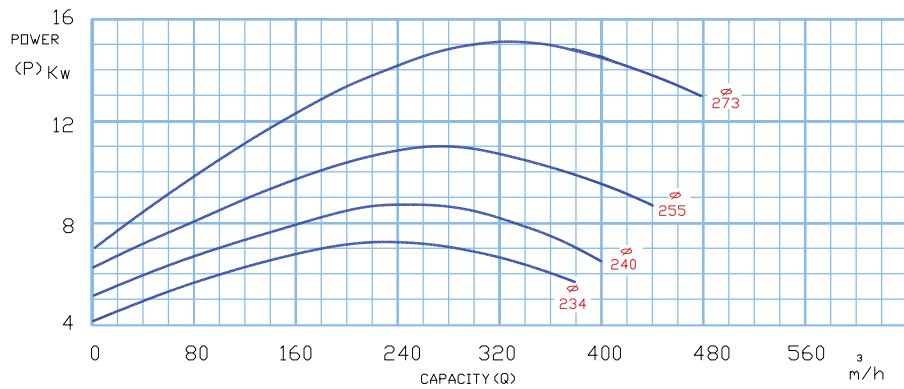
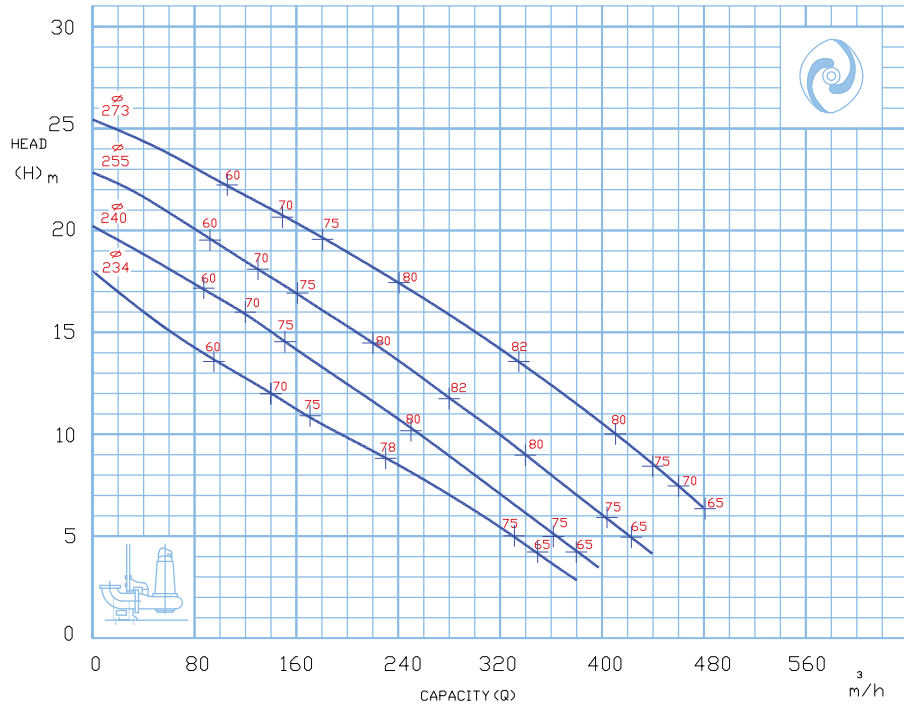

Submersible Sewage Pump

TYPE: 150-315/M	IMPELLER TYPE: Multi-channel
960 rpm	FREE PASSAGE: 58X85

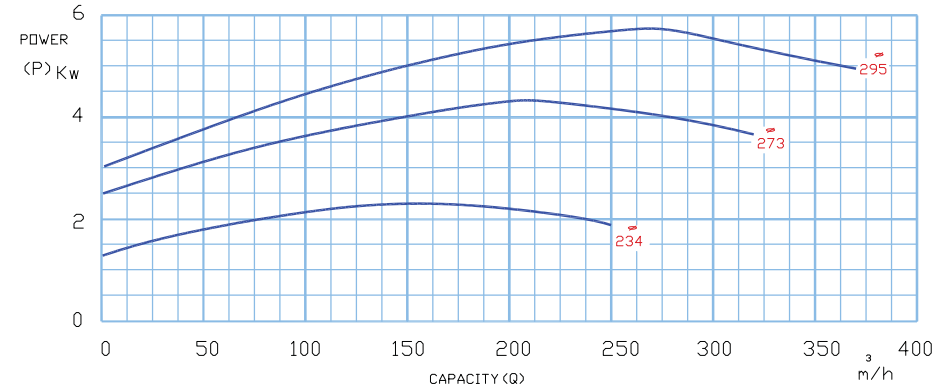
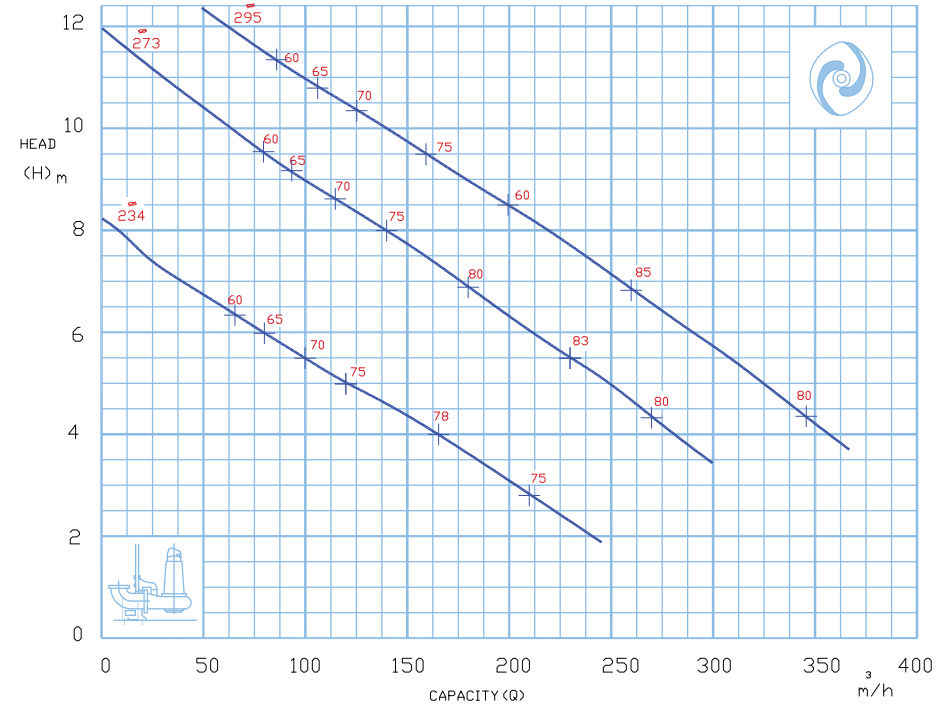

Submersible Sewage Pump

TYPE: 150-315/S	IMPELLER TYPE: Single channel
1450 rpm	FREE PASSAGE: 109ø

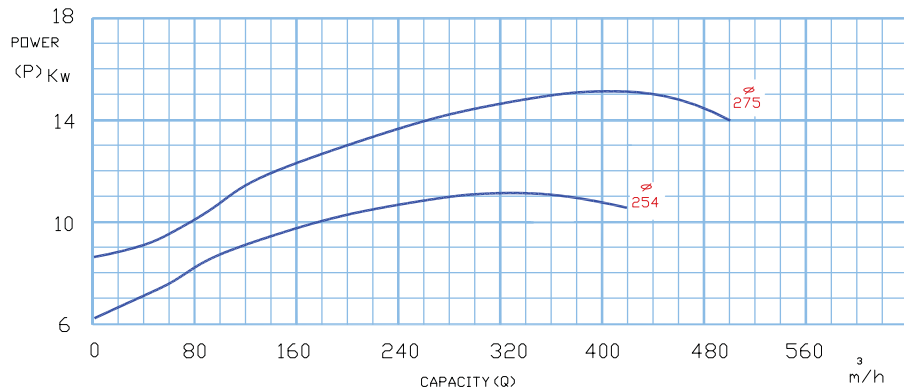
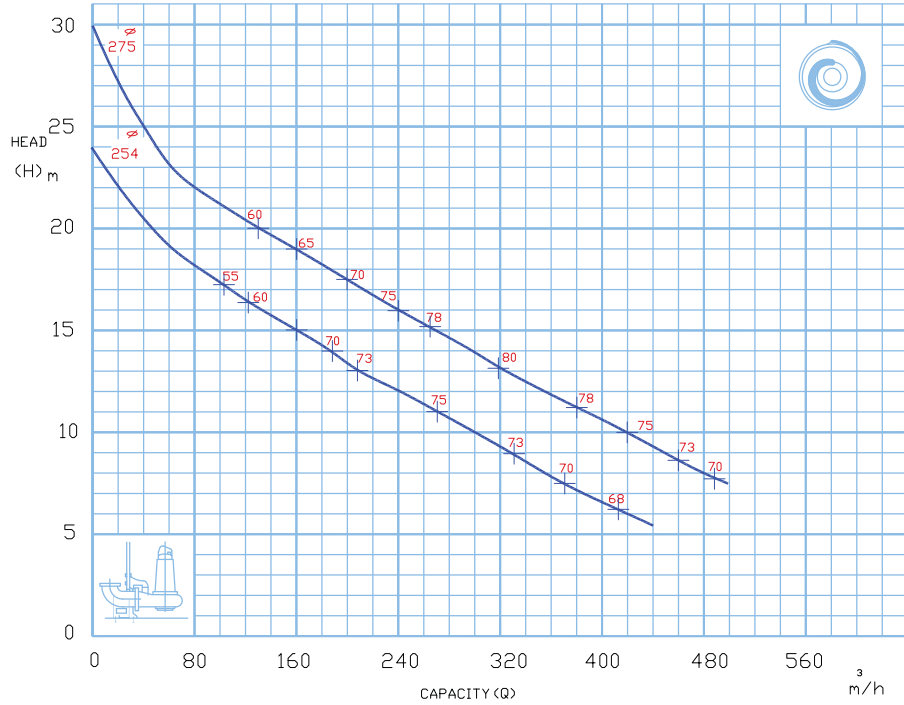

Submersible Sewage Pump

TYPE: 150-315/S	IMPELLER TYPE: Single channel
960 rpm	FREE PASSAGE: 109ø

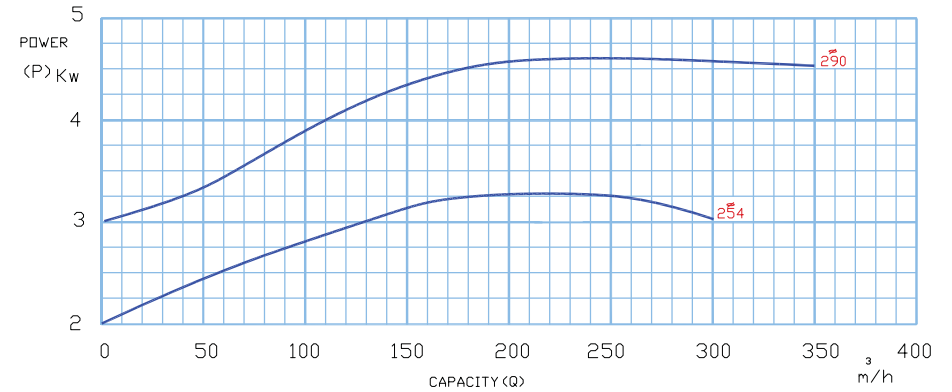
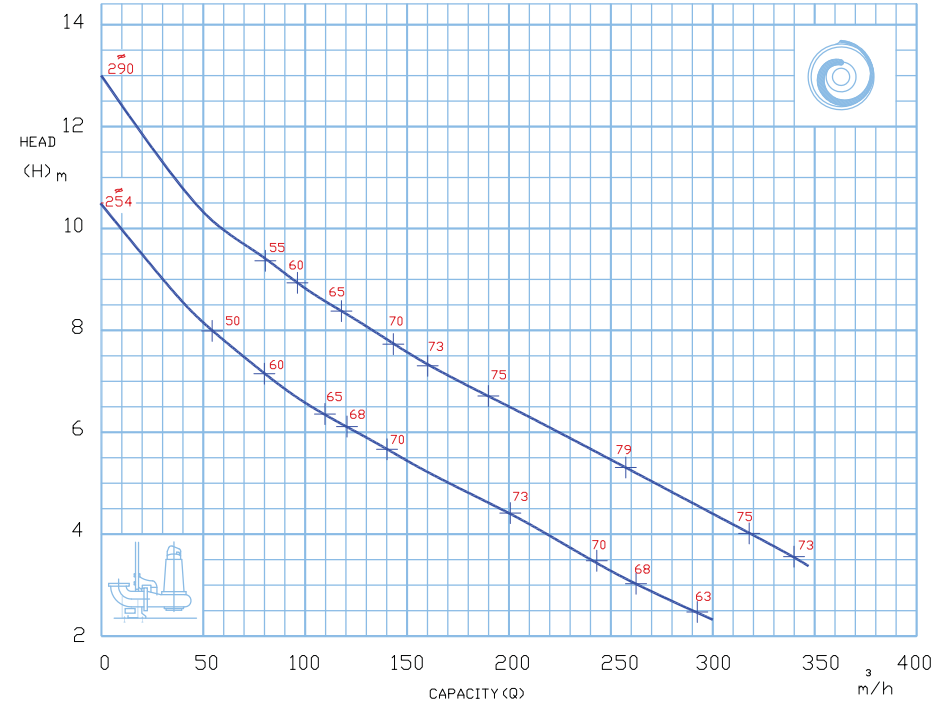

Submersible Sewage Pump

TYPE: 150-320/M	IMPELLER TYPE: Multi-channel
1450 rpm	FREE PASSAGE: 90X88

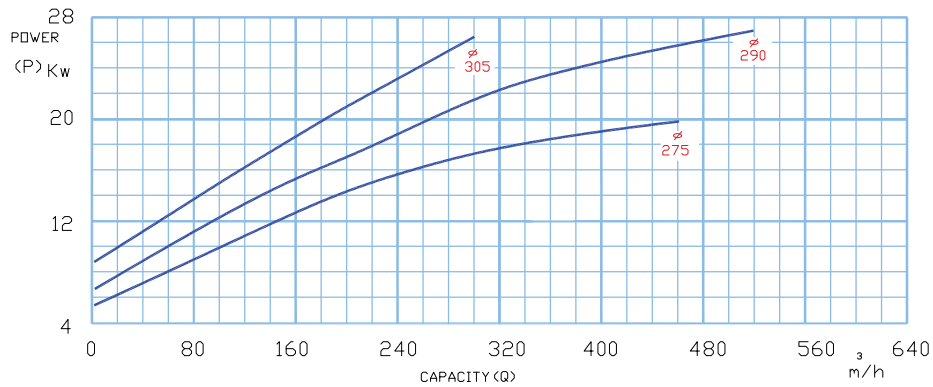
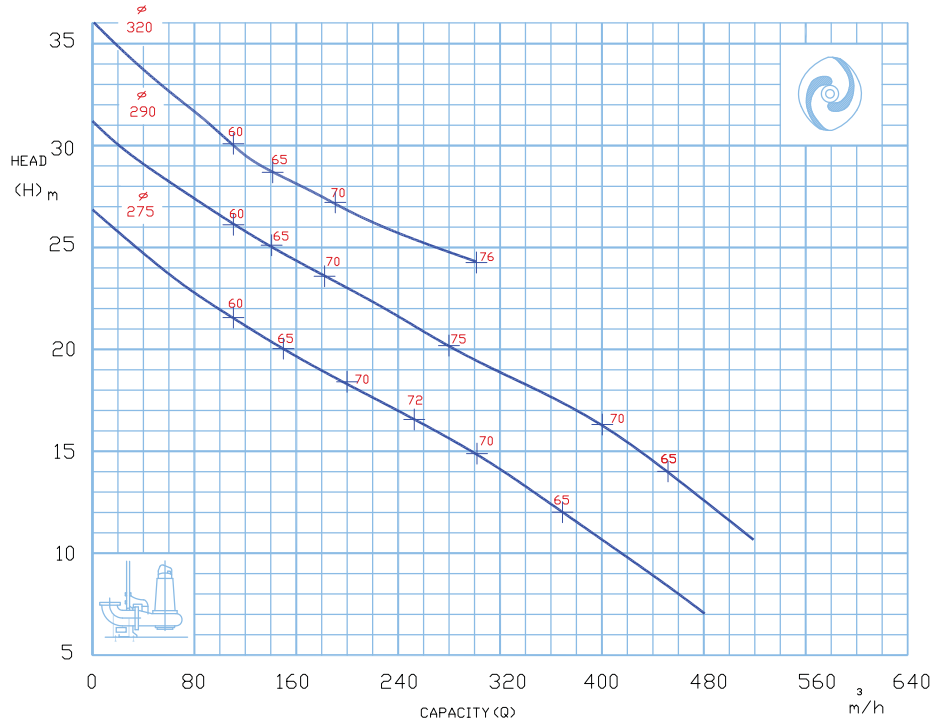

Submersible Sewage Pump

TYPE: 150-325/M	IMPELLER TYPE: Multi-channel
1450 rpm	FREE PASSAGE: 90X88

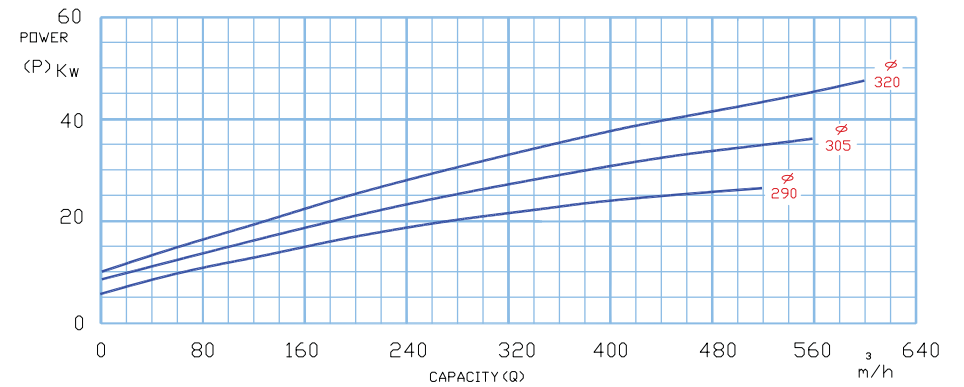
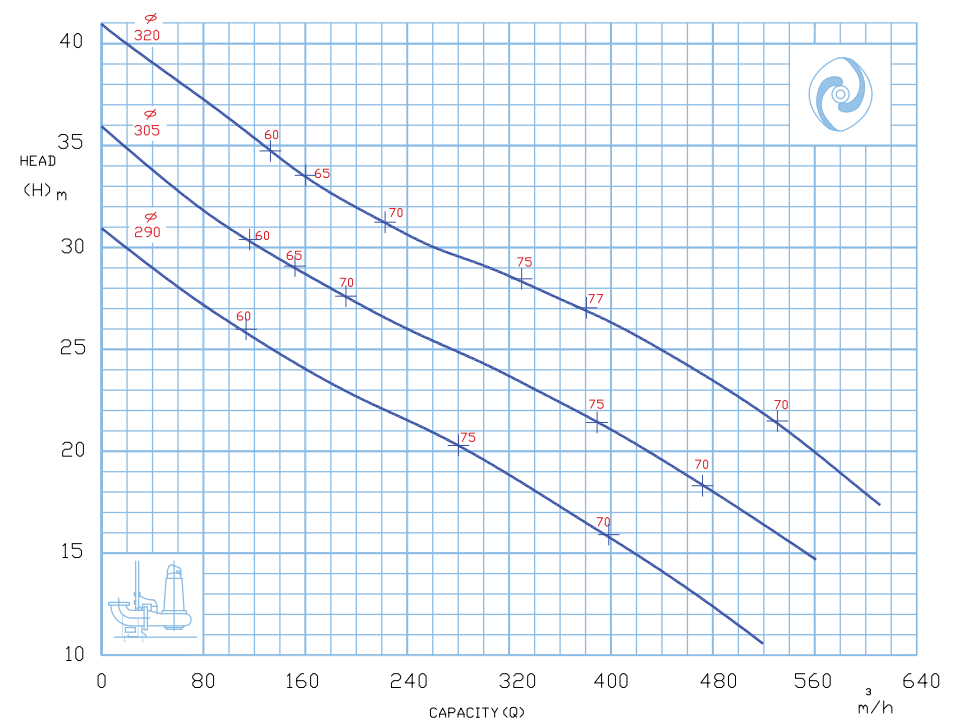

Submersible Sewage Pump

TYPE: 150-400/M	IMPELLER TYPE: Multi-channel
1450 rpm	FREE PASSAGE: 65X64

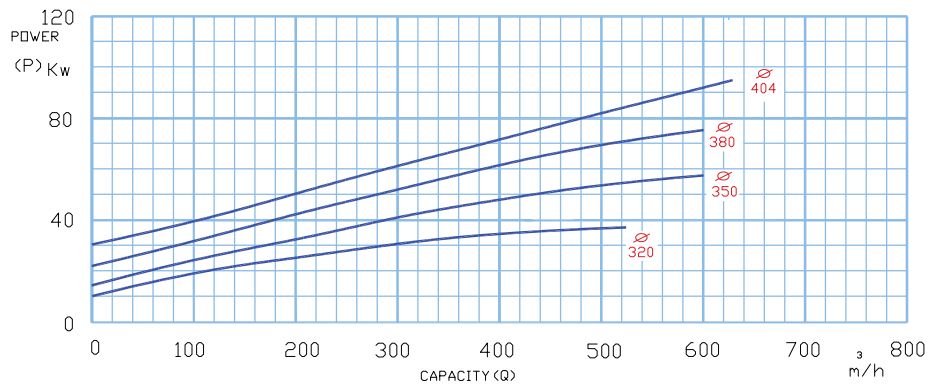
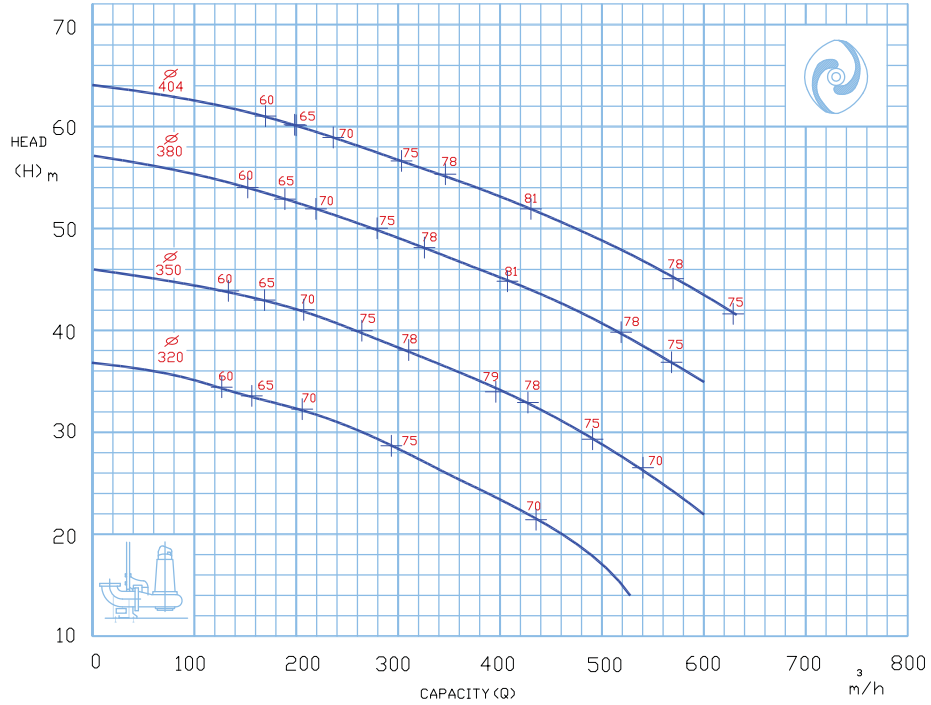

Submersible Sewage Pump

TYPE: 150-400/M	IMPELLER TYPE: Multi-channel
960 rpm	FREE PASSAGE: 65X64

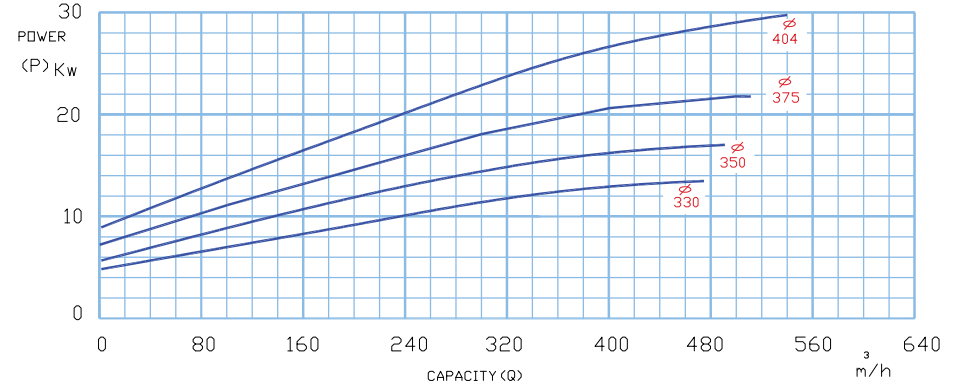
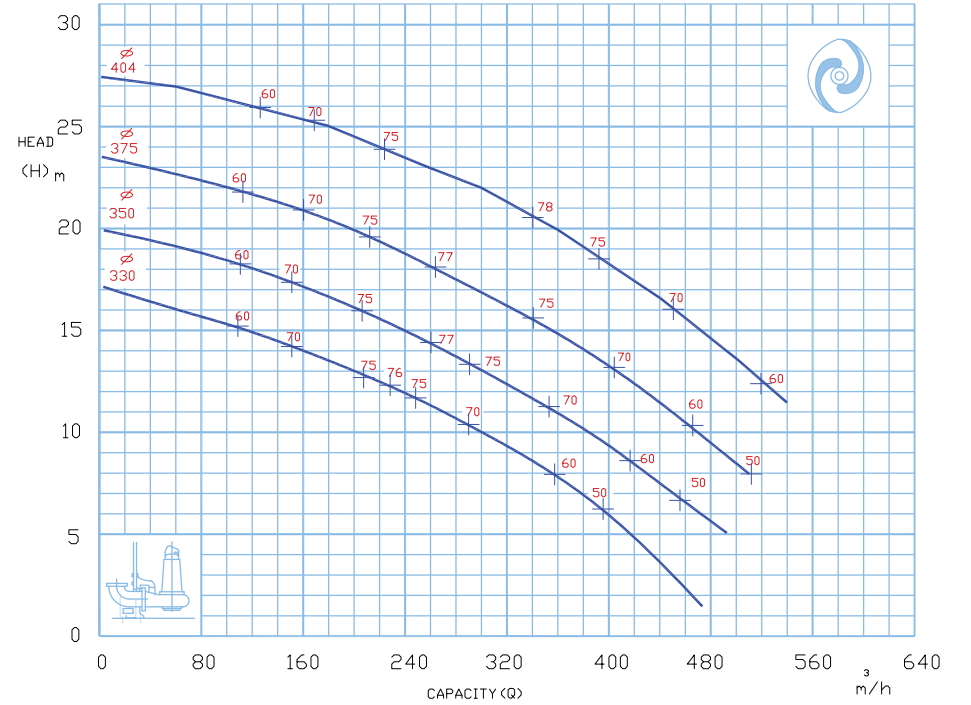

Submersible Sewage Pump

TYPE: 150-400/S	IMPELLER TYPE: Single channel
1450 rpm	FREE PASSAGE: 114ø

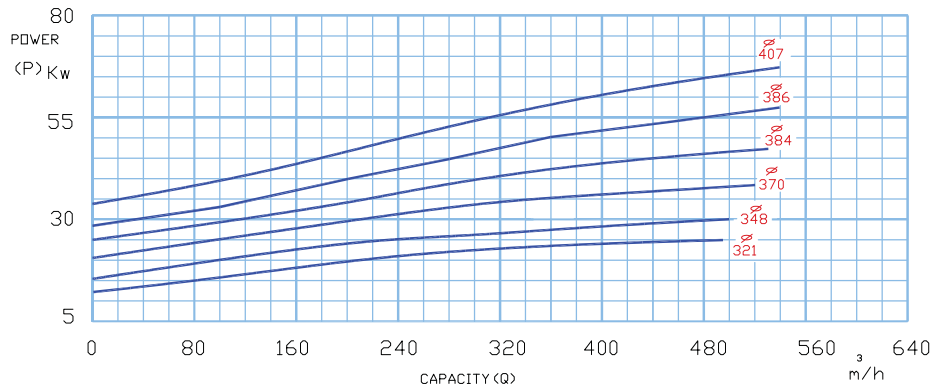
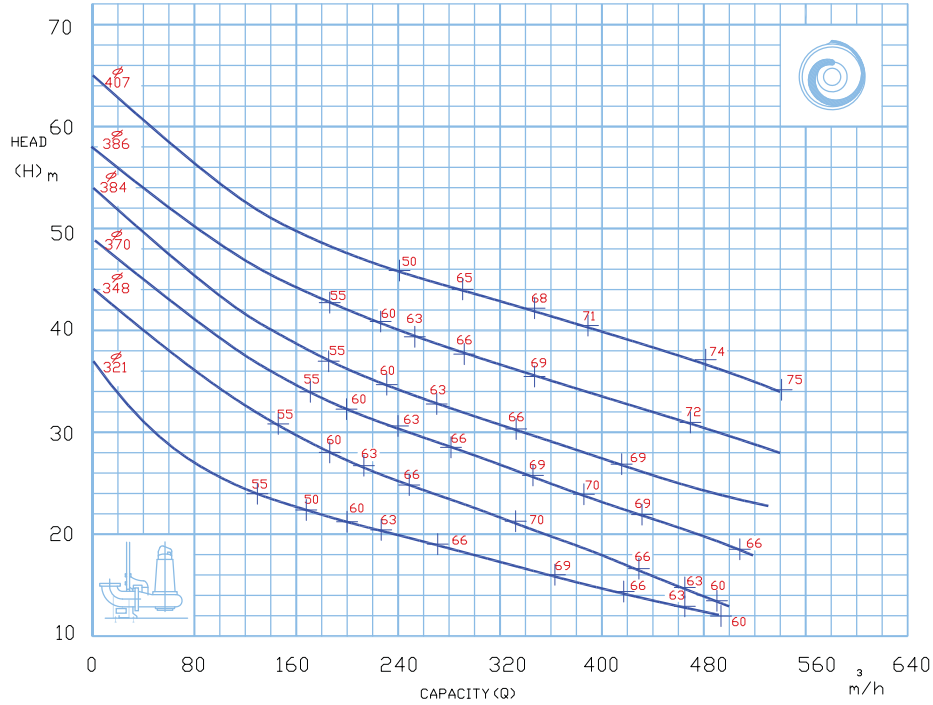

Submersible Sewage Pump

TYPE: 150-400/S	IMPELLER TYPE: Single channel
960 rpm	FREE PASSAGE: 114ø

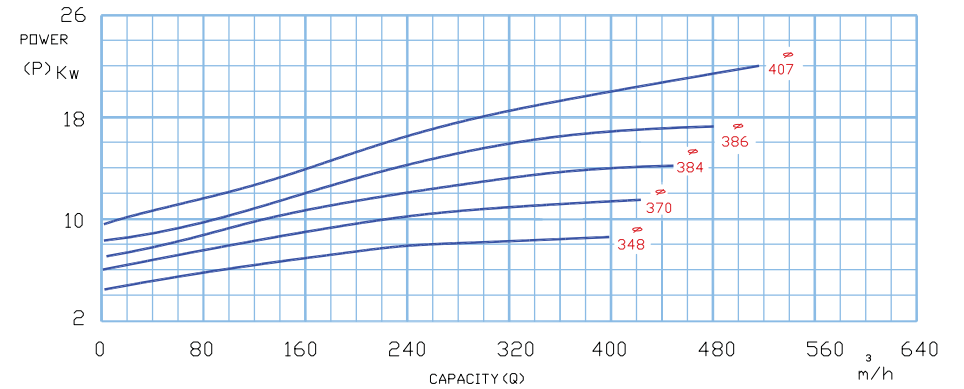
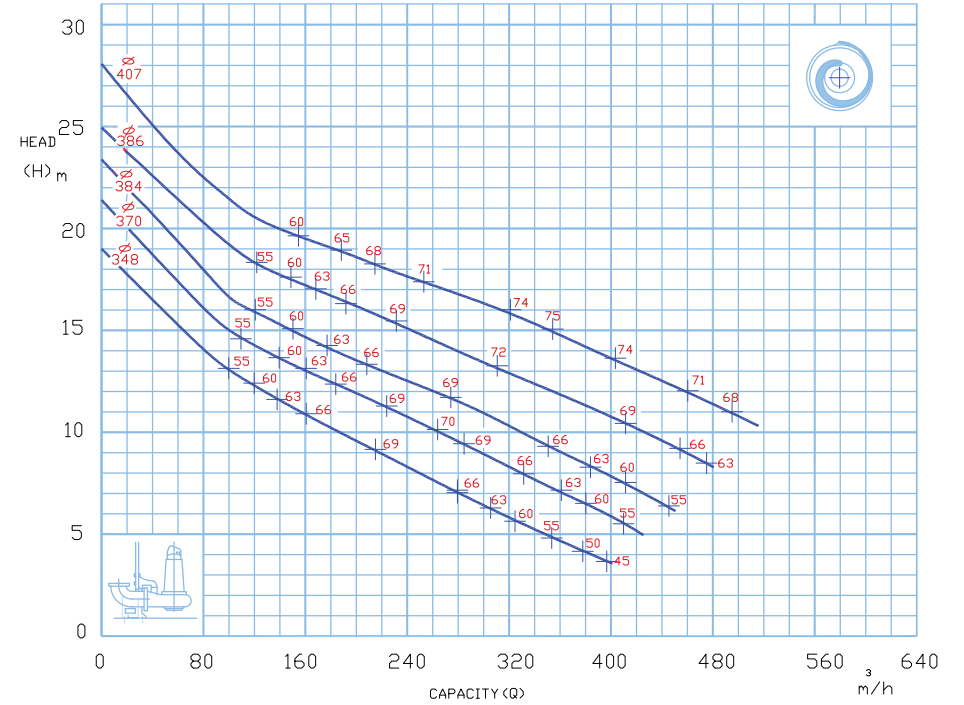

Submersible Sewage Pump

TYPE: 150-500/M	IMPELLER TYPE: Multi-channel
1450 rpm	FREE PASSAGE: 60X60

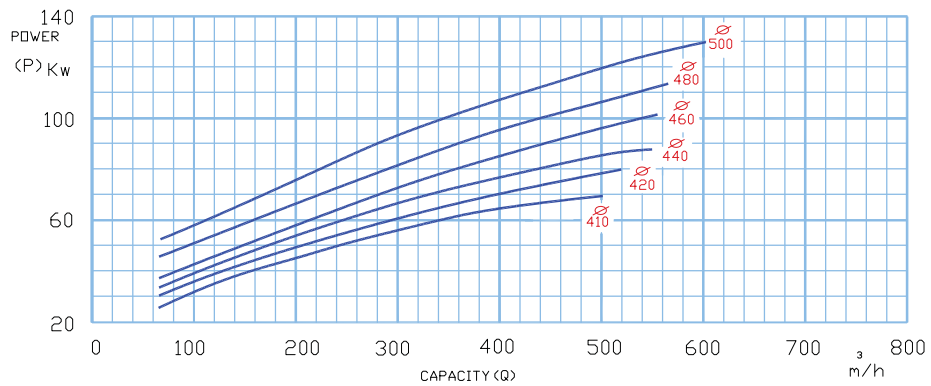
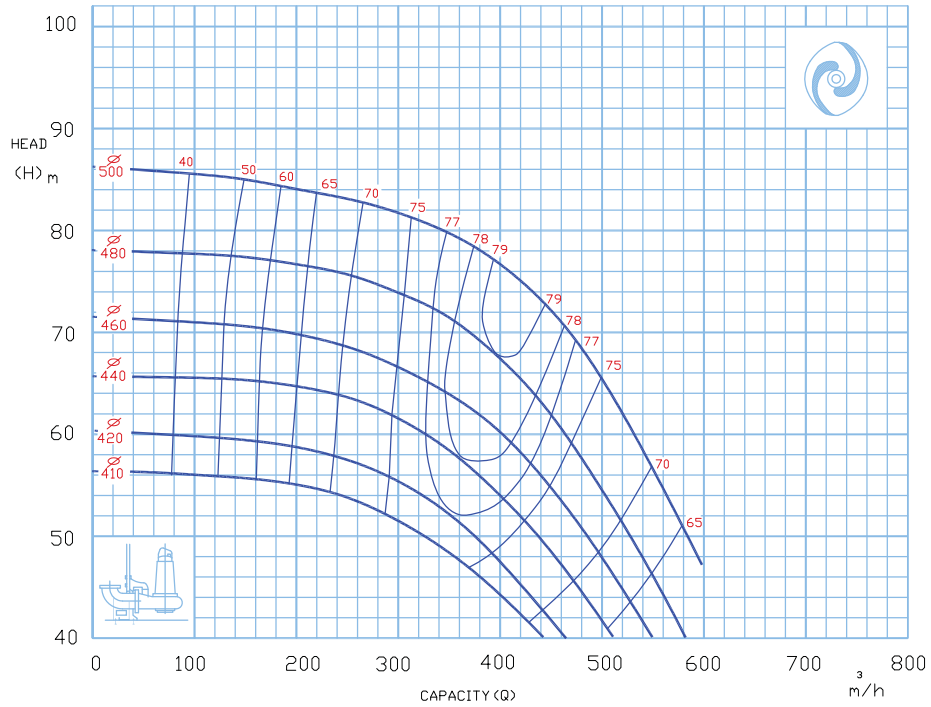

Submersible Sewage Pump

TYPE: 200-230/M	IMPELLER TYPE: Multi-channel
1450 rpm	FREE PASSAGE: 60Ø

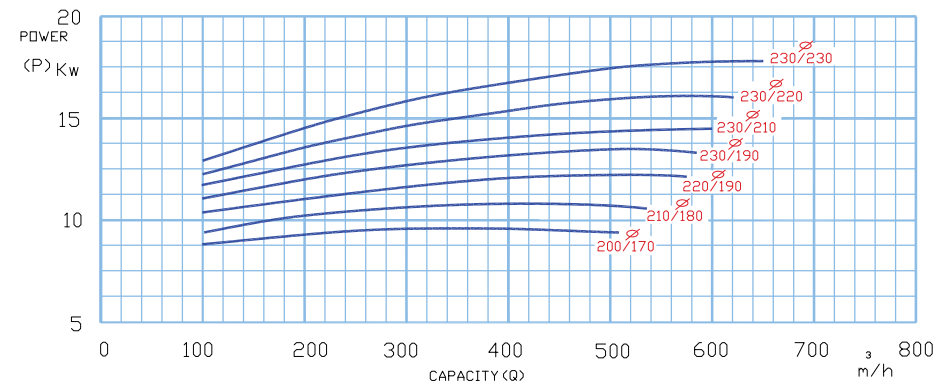
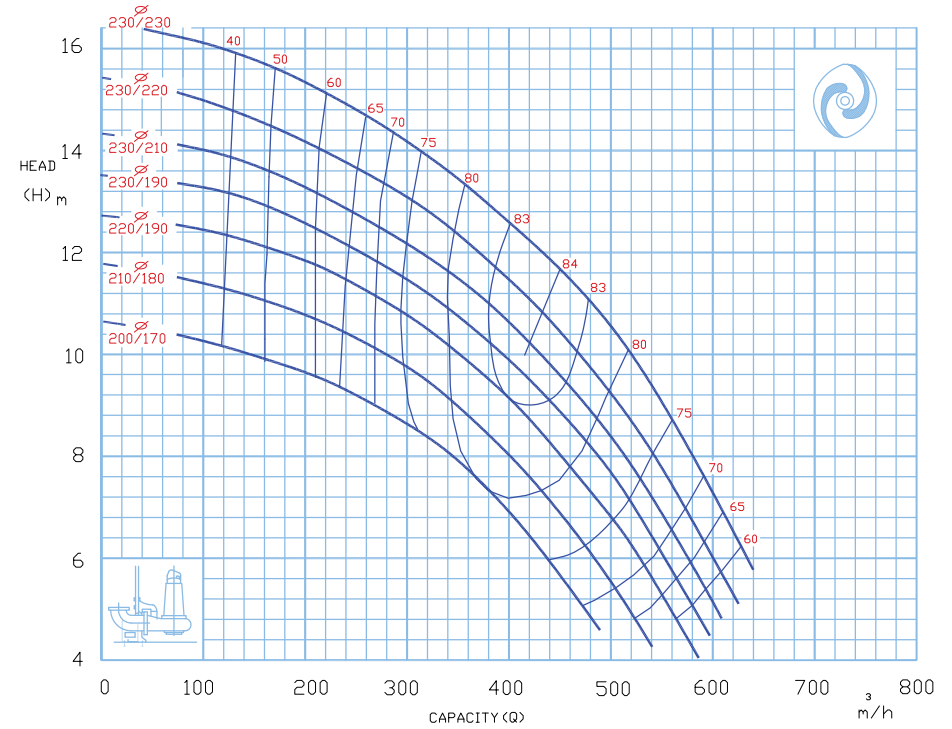

Submersible Sewage Pump

TYPE: 200-230/M	IMPELLER TYPE: Multi-channel
960 rpm	FREE PASSAGE: 60ø

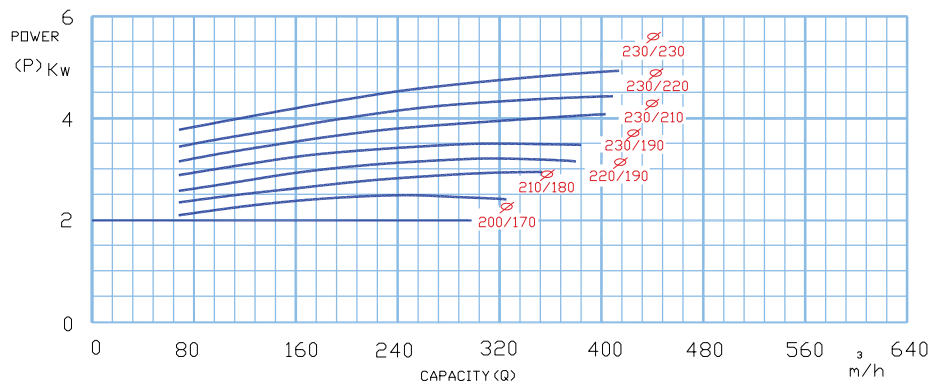
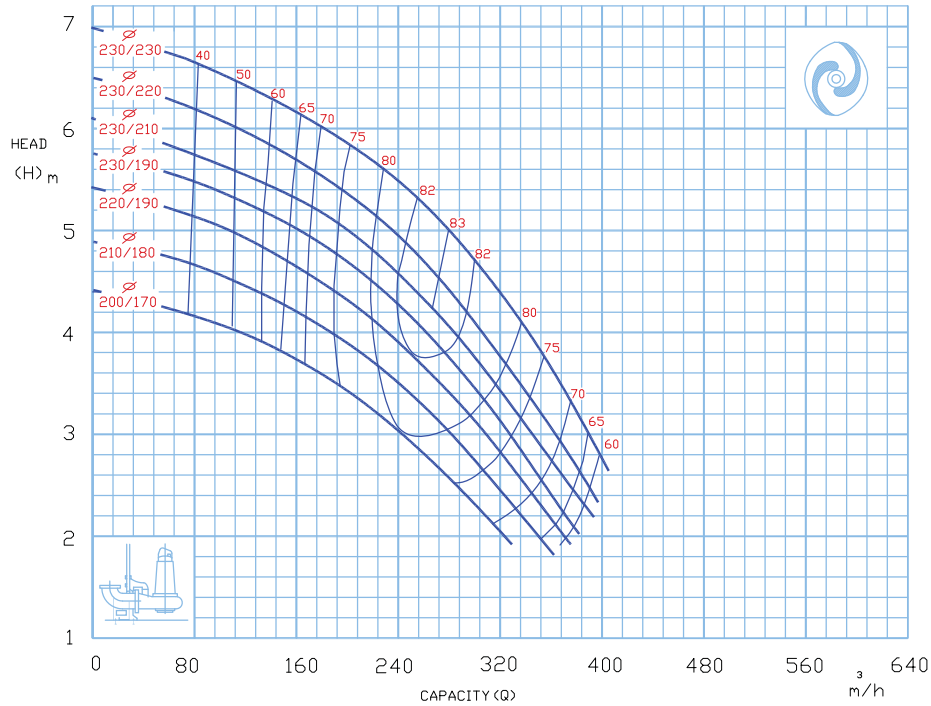

Submersible Sewage Pump

TYPE: 200-330/M	IMPELLER TYPE: Multi-channel
1450 rpm	FREE PASSAGE: 45ø

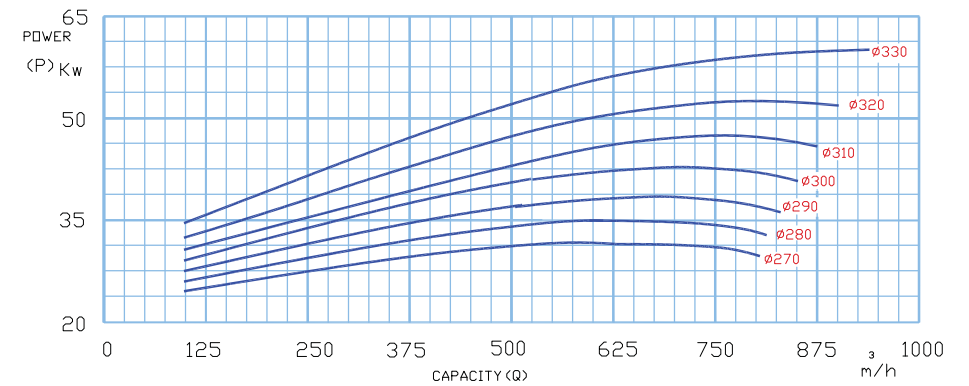
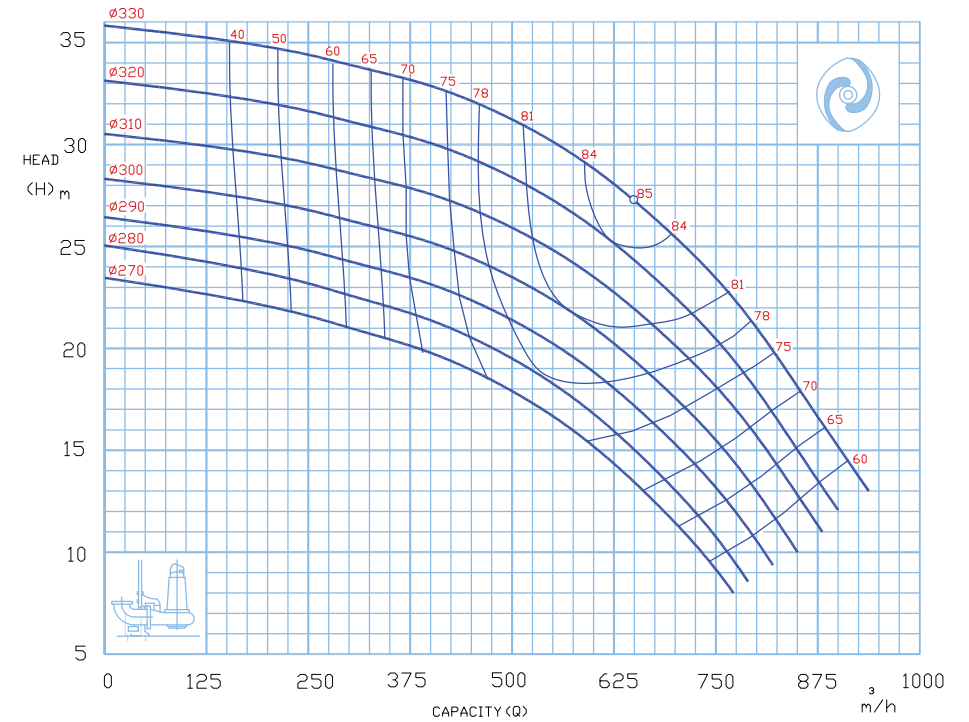

Submersible Sewage Pump

TYPE: 200-330/M	IMPELLER TYPE: Multi-channel
960 rpm	FREE PASSAGE: 45Ø

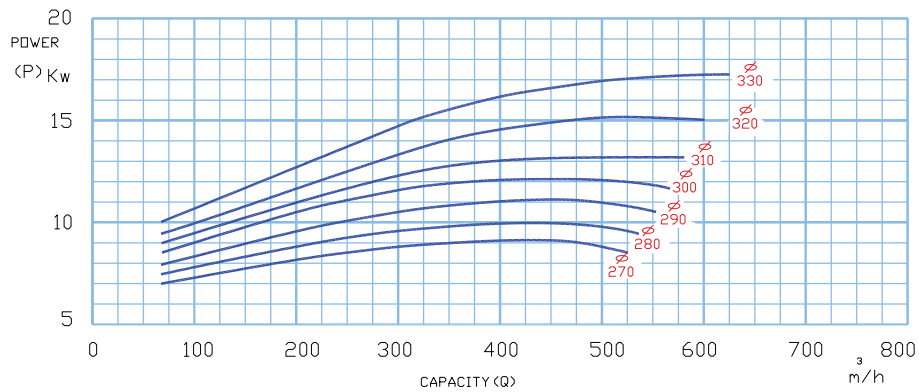
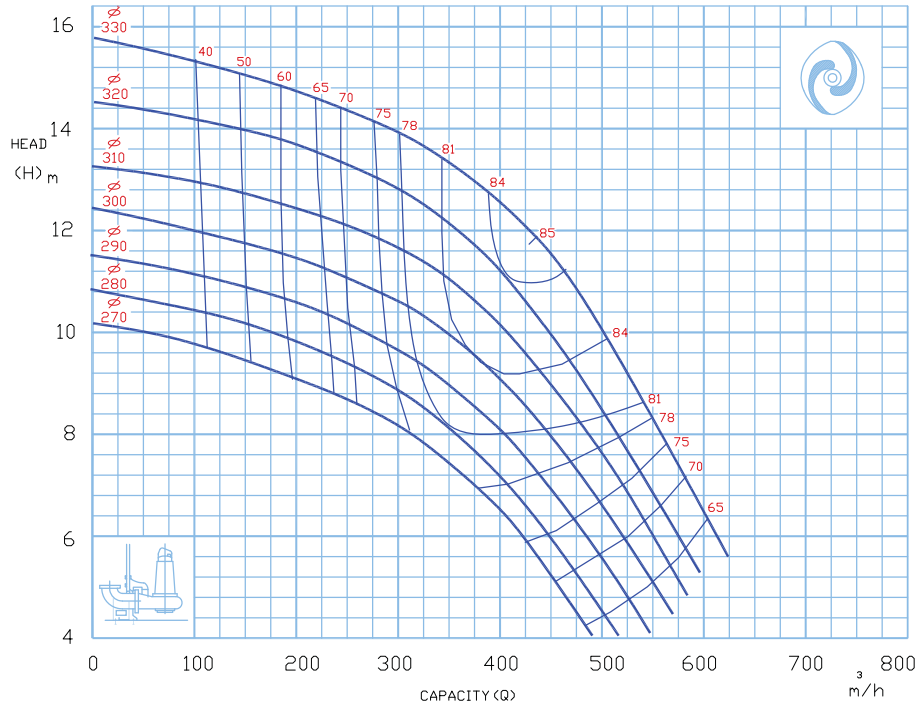

Submersible Sewage Pump

TYPE: 200-400/M	IMPELLER TYPE: Multi-channel
1450 rpm	FREE PASSAGE: 35Ø

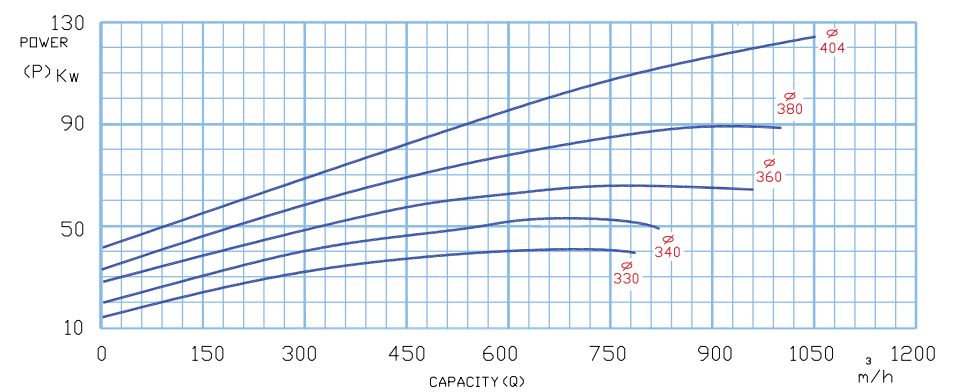
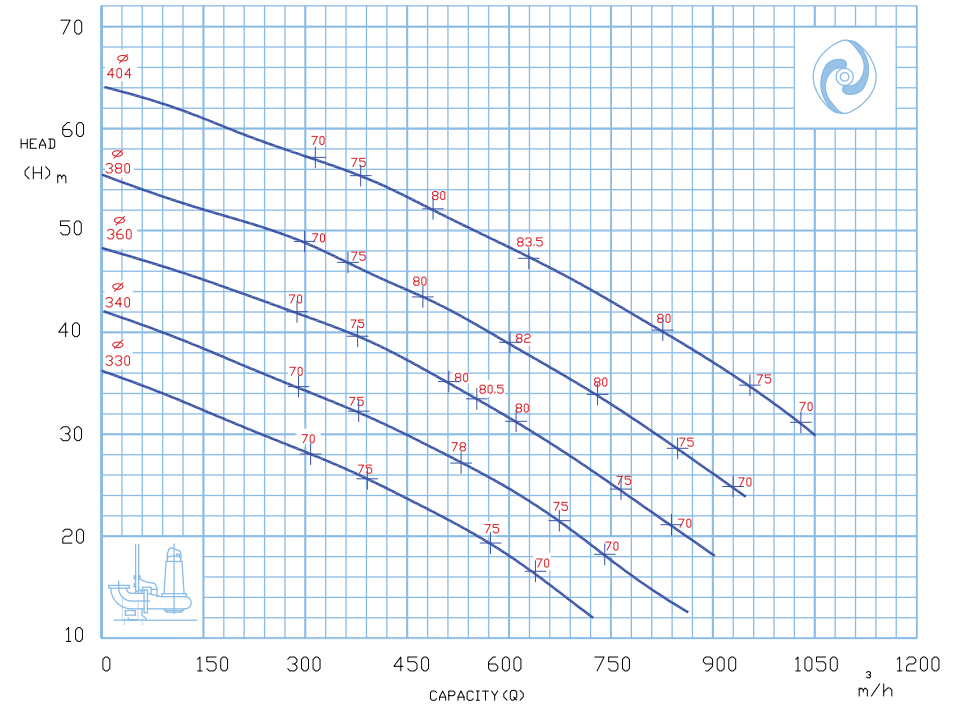

Submersible Sewage Pump

TYPE: 200-400/S	IMPELLER TYPE: Single channel
960 rpm	FREE PASSAGE: 121X160

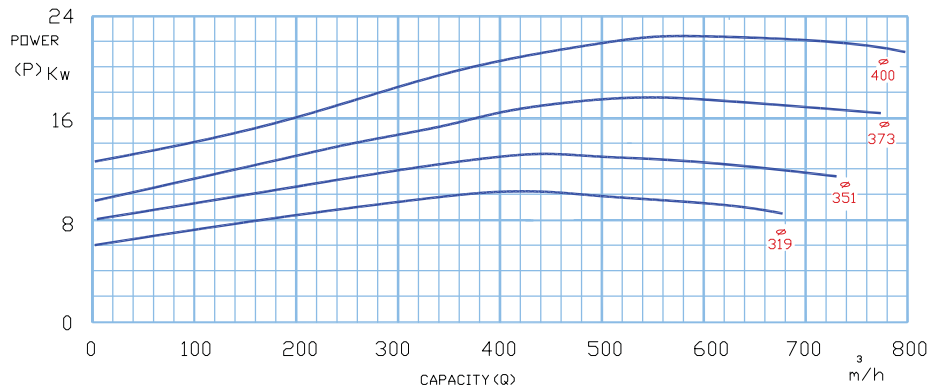
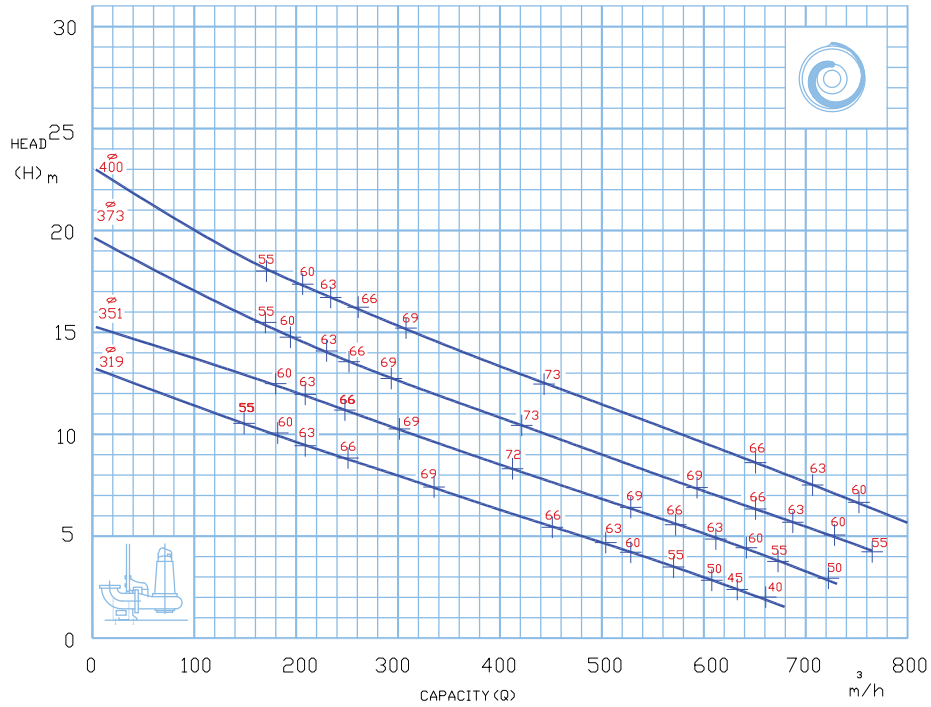

Submersible Sewage Pump

TYPE: 200-500/M	IMPELLER TYPE: Multi-channel
1450 rpm	FREE PASSAGE: 28ø

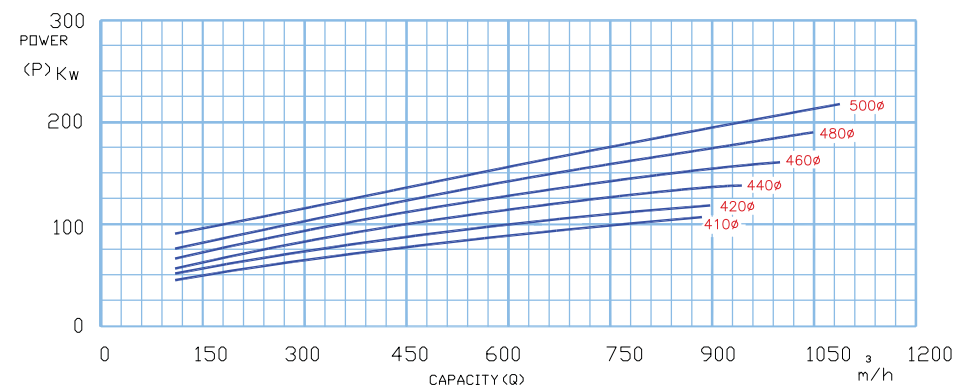
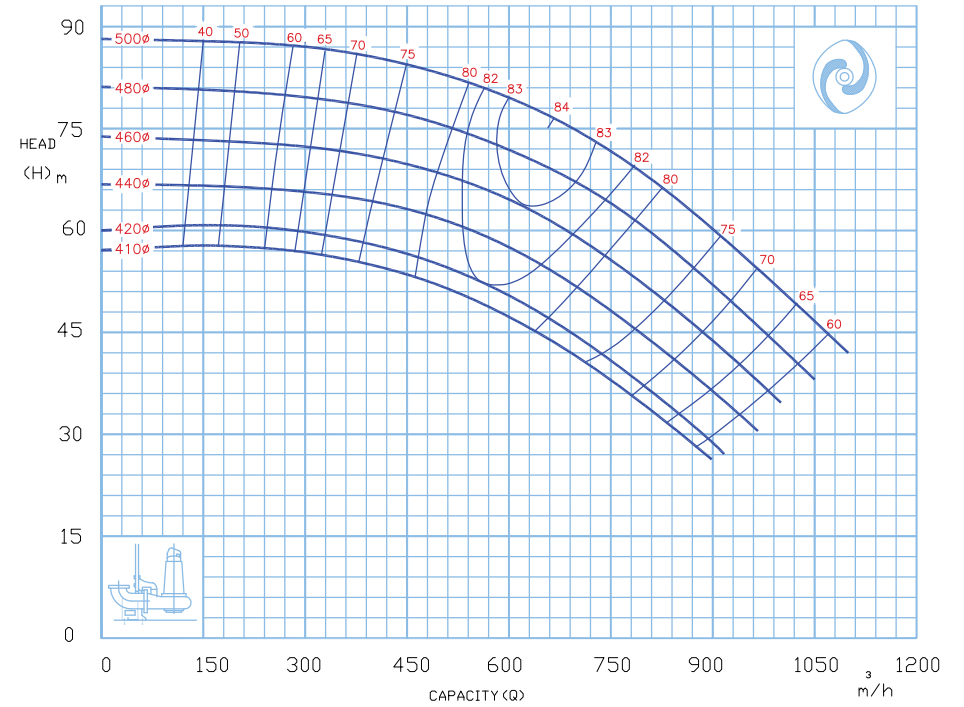

Submersible Sewage Pump

TYPE: 250-290/M	IMPELLER TYPE: Multi-channel
1450 rpm	FREE PASSAGE: 75Ø

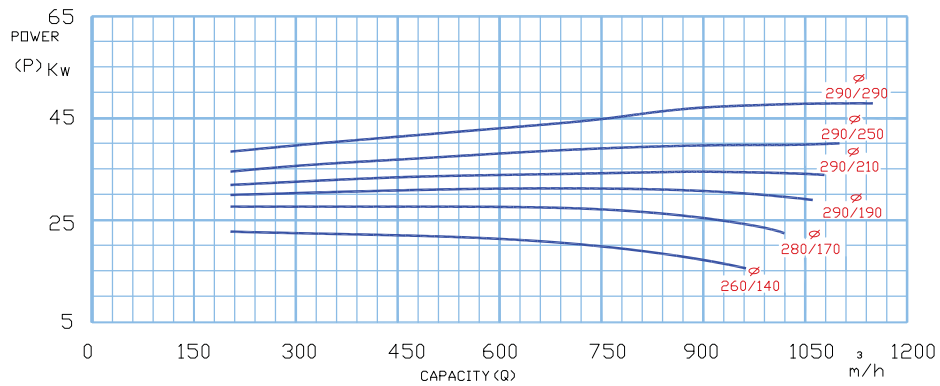
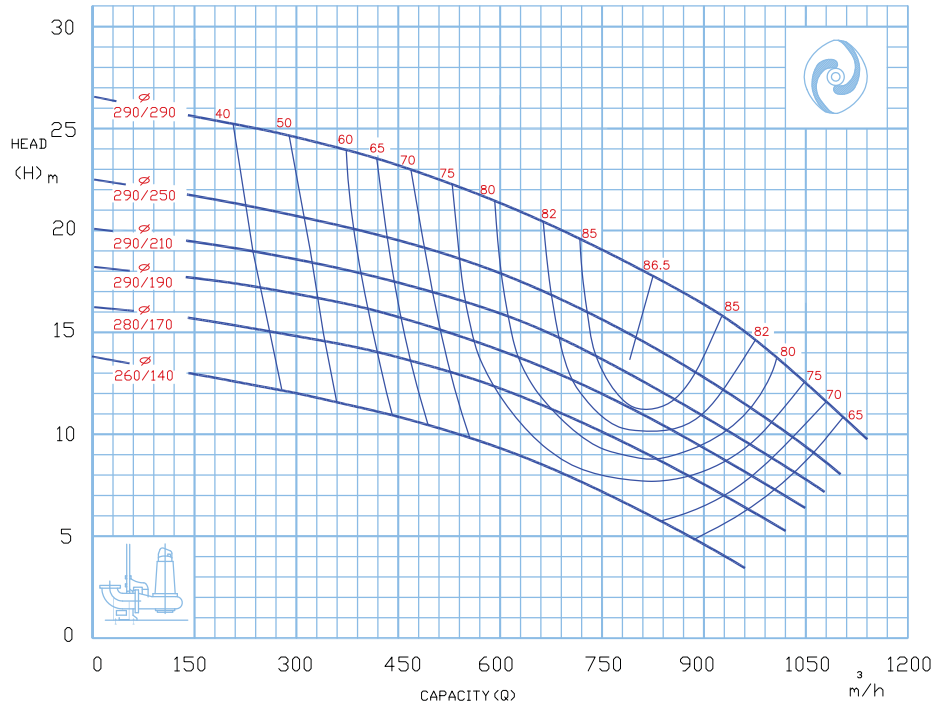

Submersible Sewage Pump

TYPE: 250-290/M	IMPELLER TYPE: Multi-channel
960 rpm	FREE PASSAGE: 75Ø

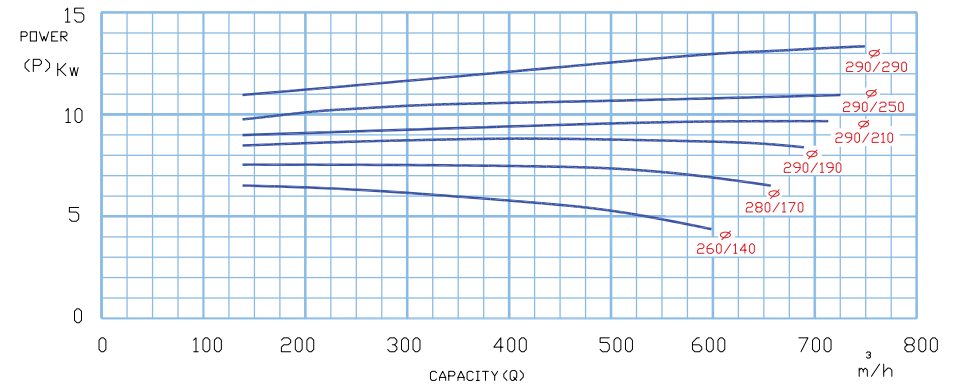
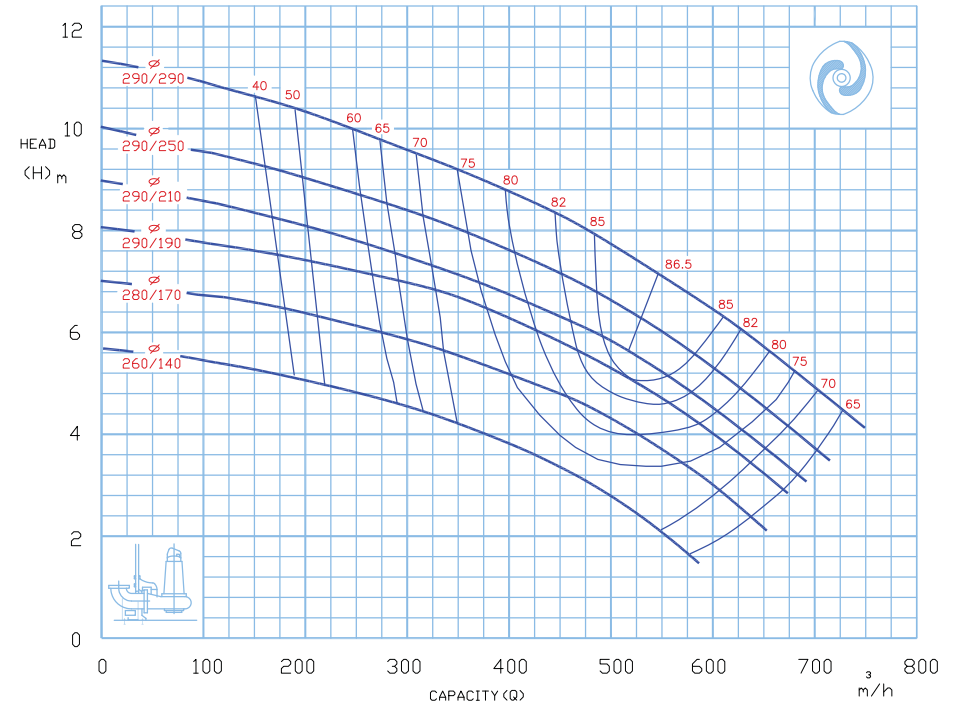

Submersible Sewage Pump

TYPE: 250-330/M	IMPELLER TYPE: Multi-channel
1450 rpm	FREE PASSAGE: 68ø

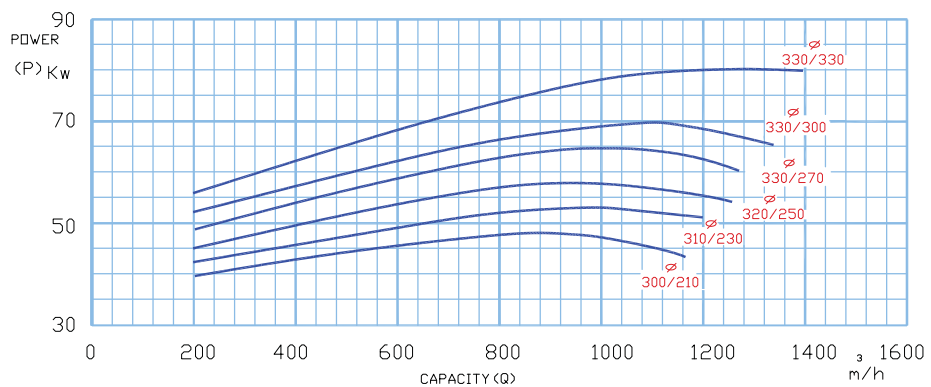
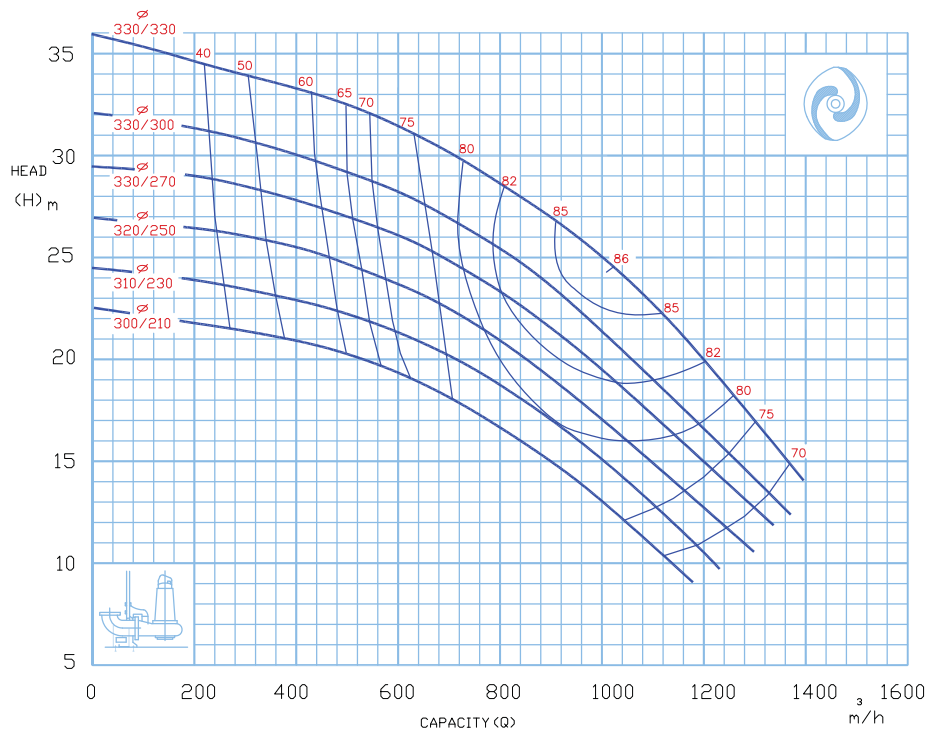

Submersible Sewage Pump

TYPE: 250-330/M	IMPELLER TYPE: Multi-channel
960 rpm	FREE PASSAGE: 68ø

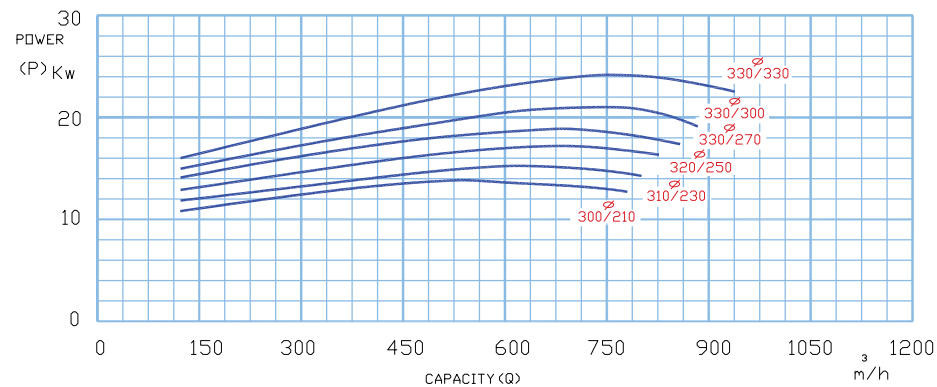
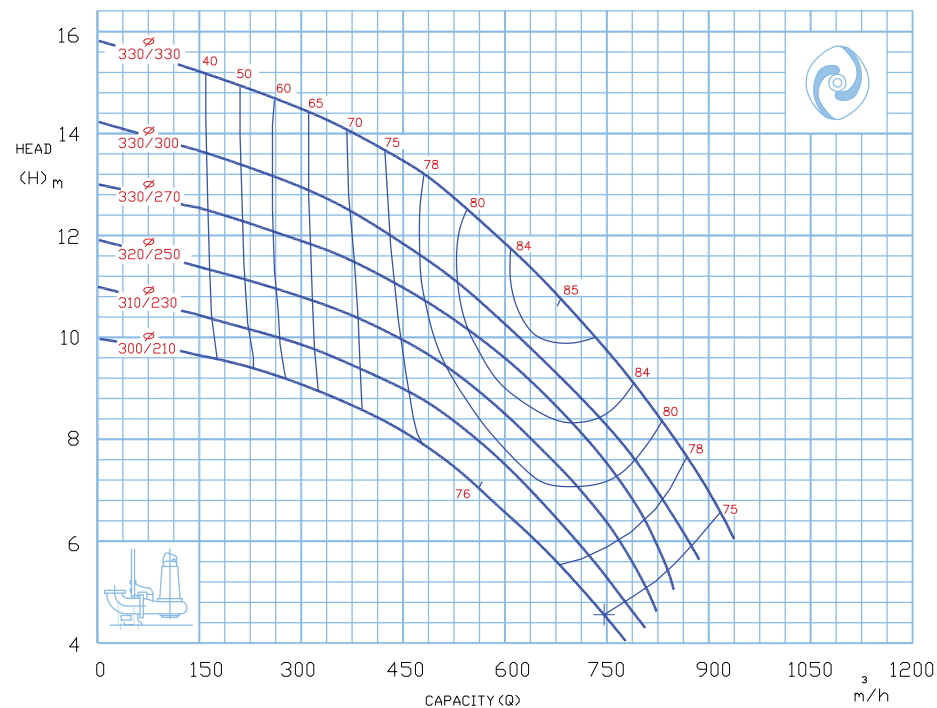

Submersible Sewage Pump

TYPE: 250-400/M	IMPELLER TYPE: Multi-channel
1450 rpm	FREE PASSAGE: 55ø

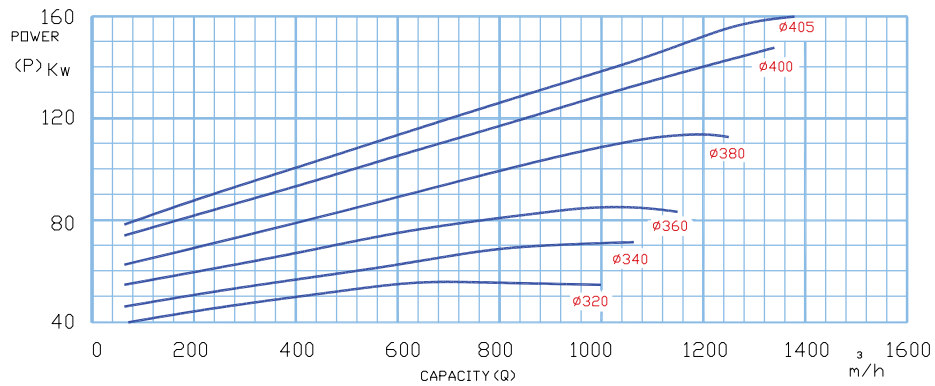
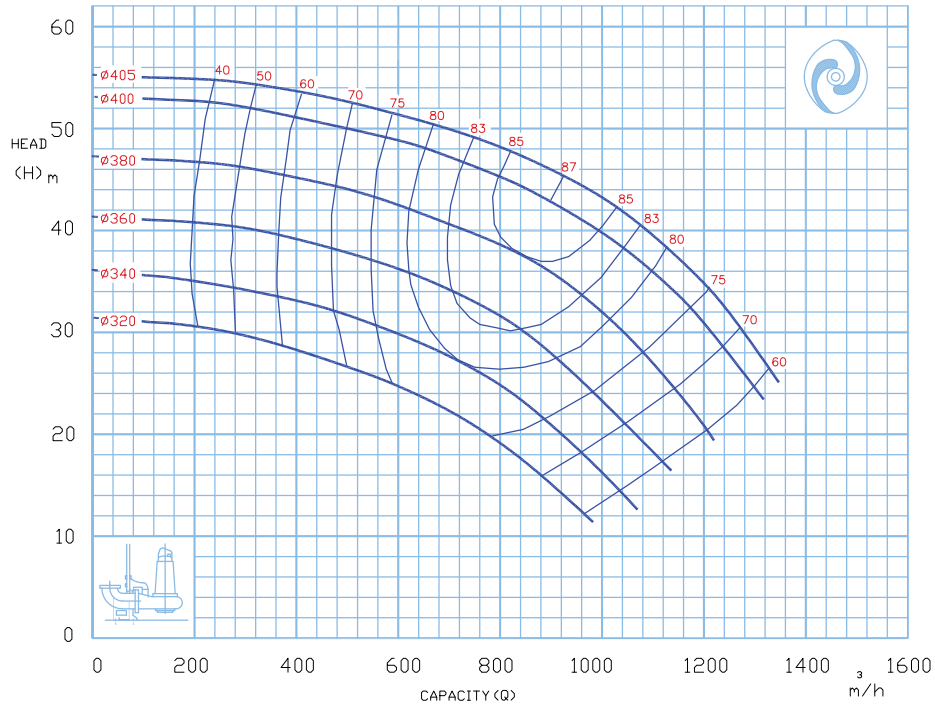

Submersible Sewage Pump

TYPE: 250-400/M	IMPELLER TYPE: Multi-channel
960 rpm	FREE PASSAGE: 55ø

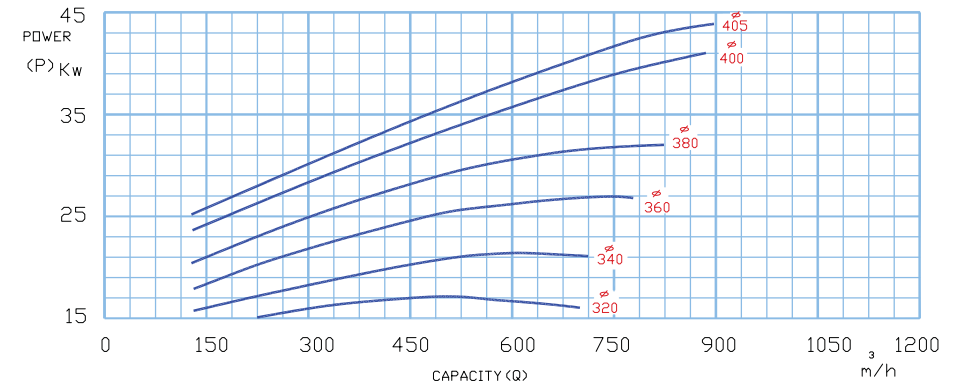
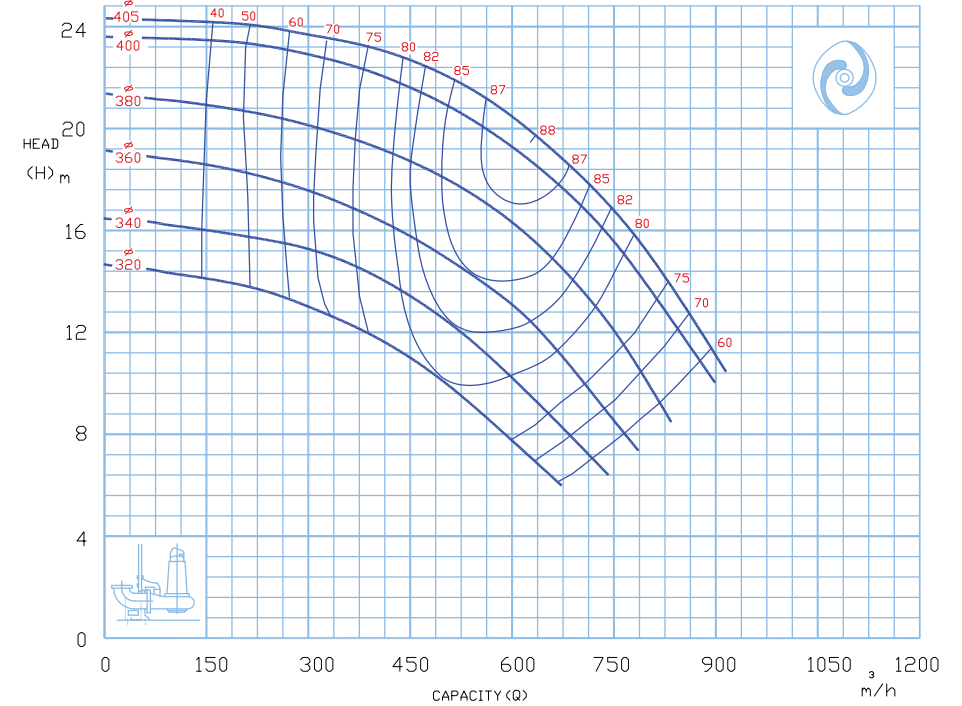

Submersible Sewage Pump

TYPE: 250-500/M
1460 rpm

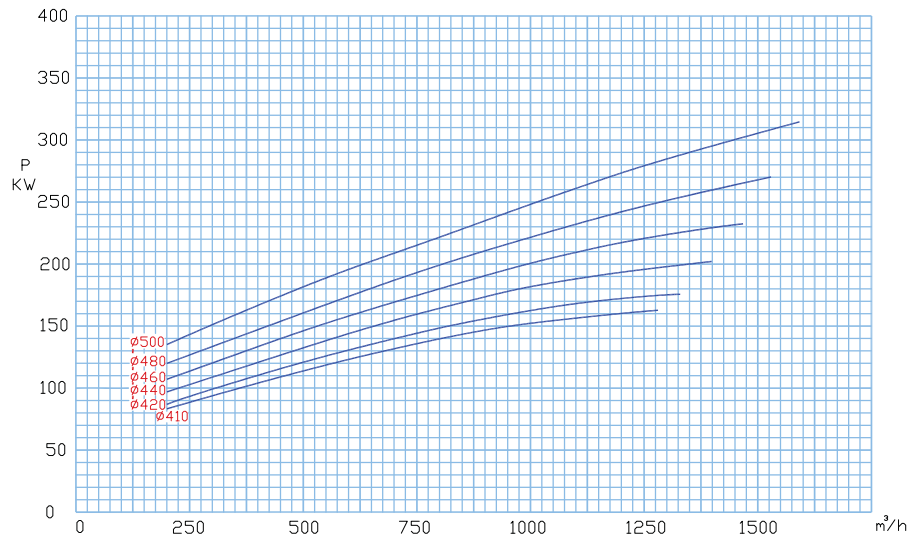
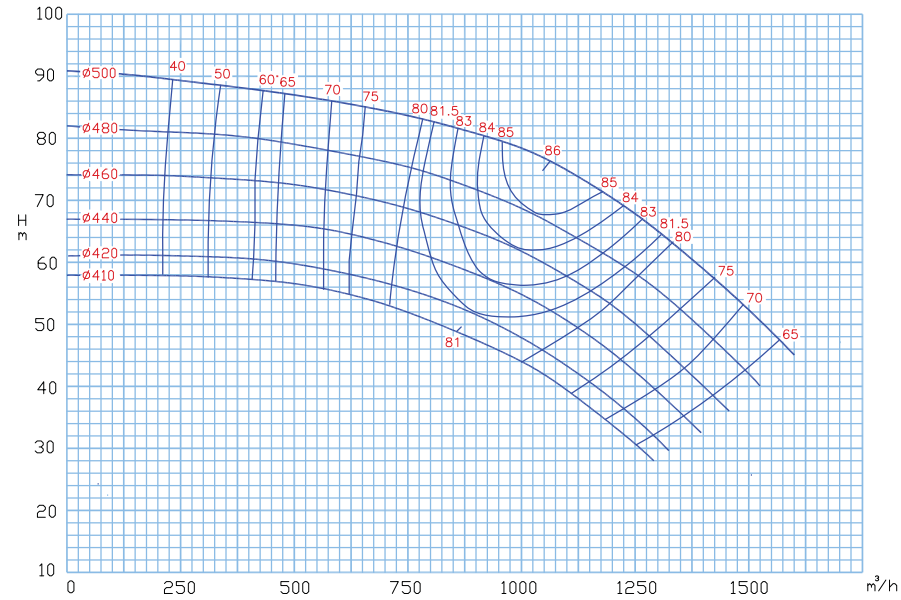

Submersible Sewage Pump

TYPE: 250-500/M
970 rpm

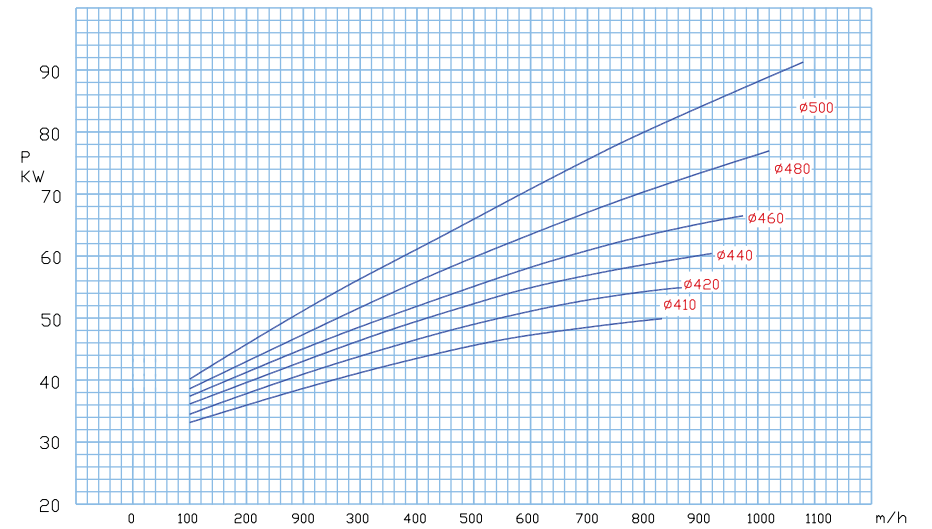
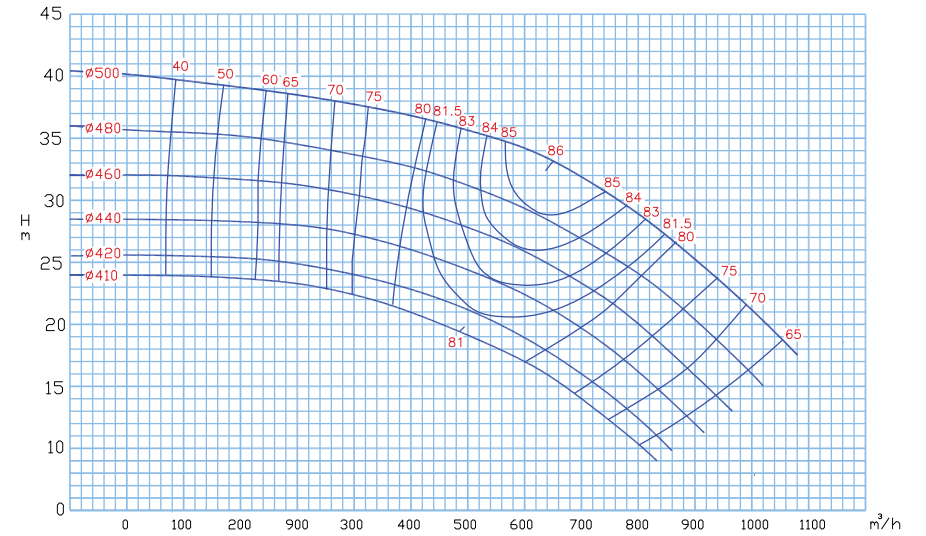

Submersible Sewage Pump

TYPE: 300-350

1460 rpm

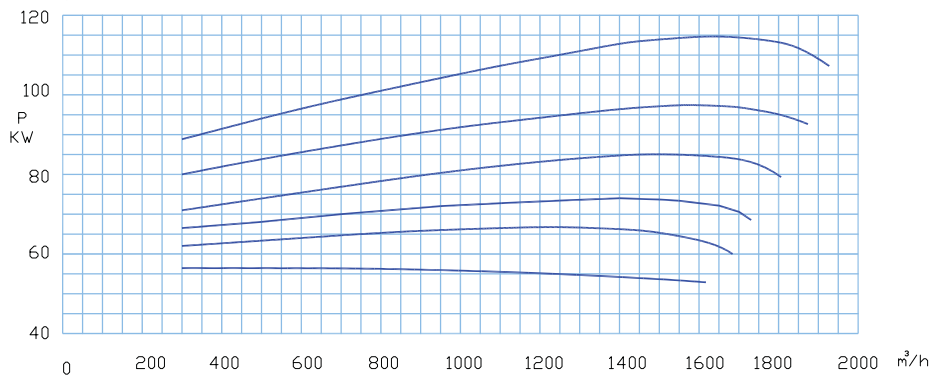
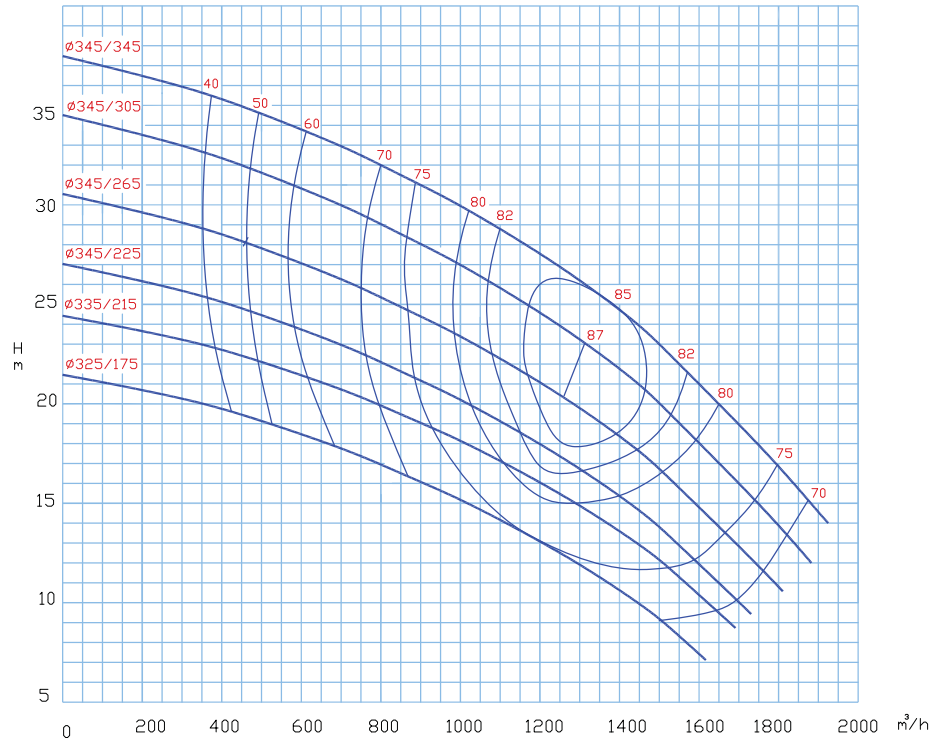

Submersible Sewage Pump

TYPE: 300-350/M

IMPELLER TYPE: Multi-channel

1450 rpm

FREE PASSAGE: 95ø

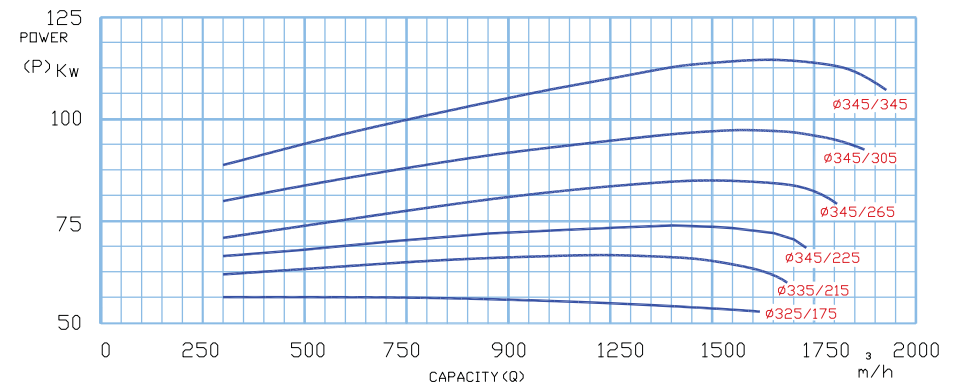
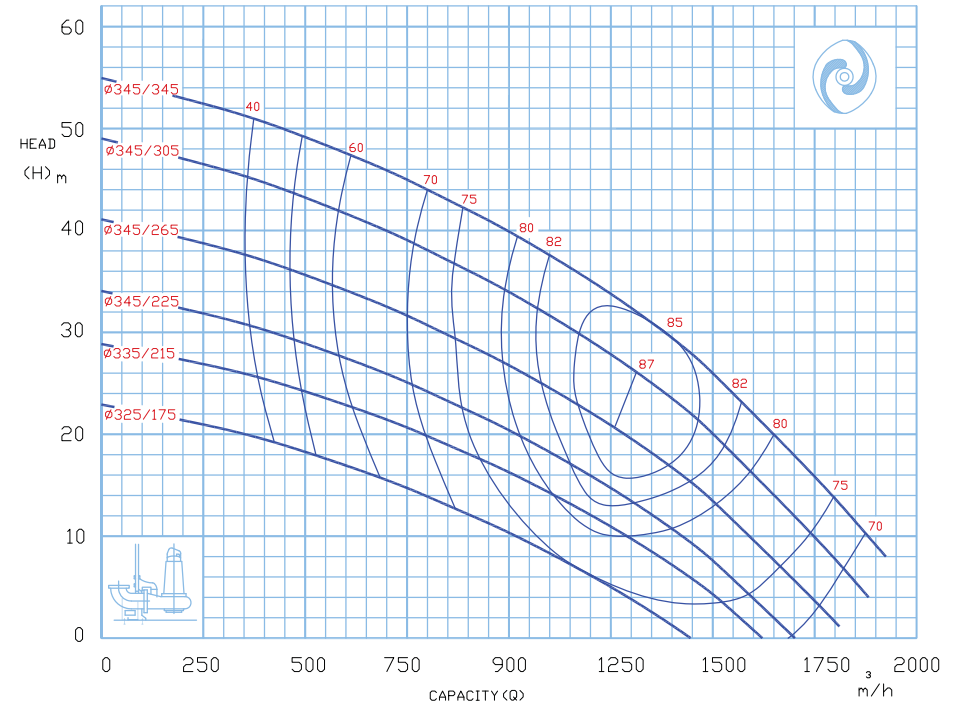

Submersible Sewage Pump

TYPE: 300-350/M	IMPELLER TYPE: Multi-channel
1460 rpm	

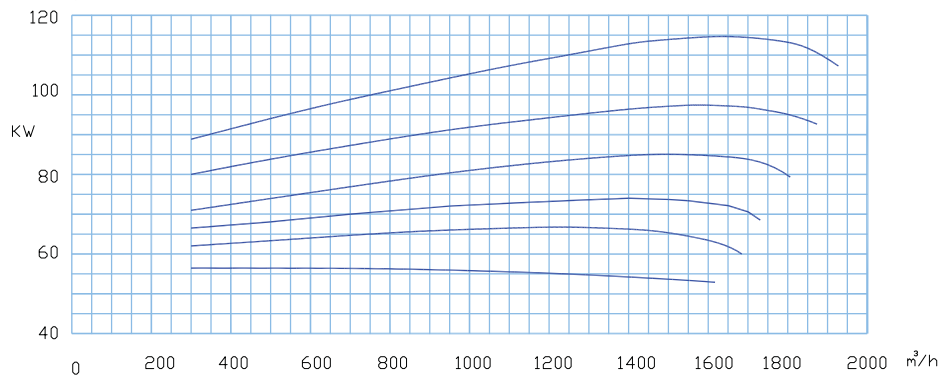
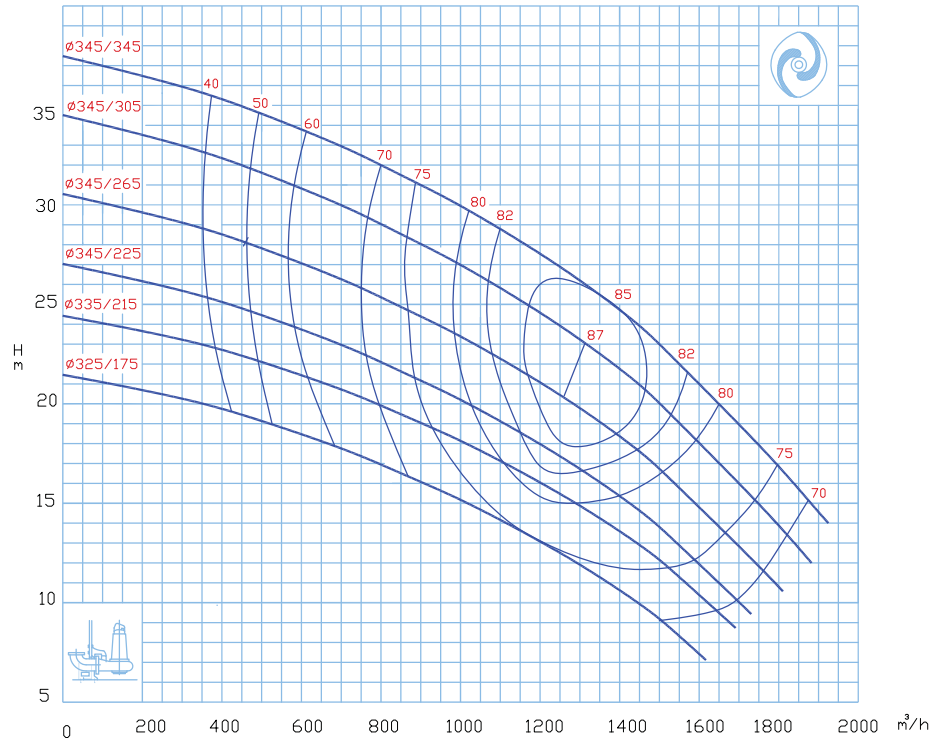

Submersible Sewage Pump

TYPE: 300-350/M	IMPELLER TYPE: Multi-channel
960 rpm	FREE PASSAGE: 95 ϕ

